

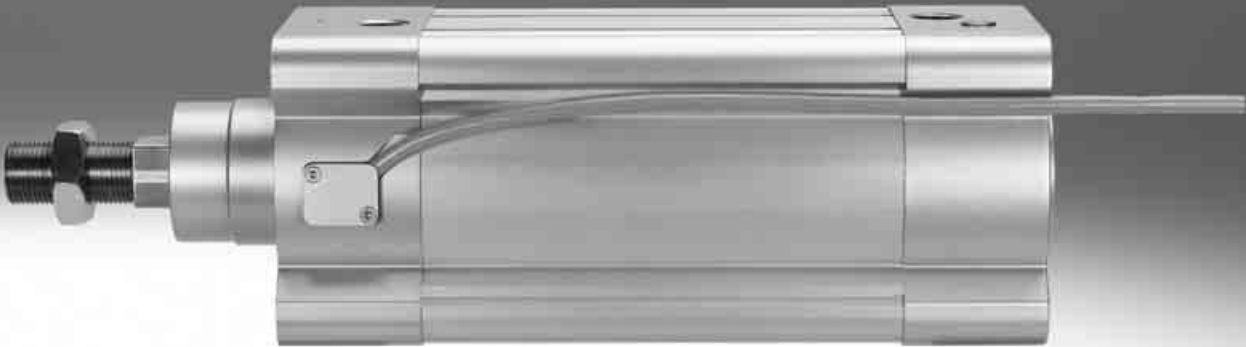















Standard cylinders DDPC, integrated displacement encoder



Cylinders with displacement encoder

Product range overview

Function	Type	Description
Drives	Rodless	
	DDLI 	<ul style="list-style-type: none"> • Without guide • With contactless measuring displacement encoder • Based on linear drive DGC-K • Supply ports on end face • System product for handling and assembly technology
	DDCI 	<ul style="list-style-type: none"> • With guide • With contactless measuring displacement encoder • Based on linear drive DGC • Supply ports optionally on end face or front • System product for handling and assembly technology
	With piston rod	
	DNCI 	<ul style="list-style-type: none"> • With contactless measuring displacement encoder • Various piston rod variants • Standards-based cylinder to ISO 15552 <p>    </p>
	DDCP 	<ul style="list-style-type: none"> • With contactless measuring displacement encoder • Various piston rod variants • Standards-based cylinder to ISO 15552 <p>    </p>
DNC/DSBC 	<ul style="list-style-type: none"> • With attached potentiometer MLO-LWG • Various piston rod variants • Standards-based cylinder to ISO 15552 <p>    </p>	
Swivel modules	Swivel modules	
	DSMI 	<ul style="list-style-type: none"> • Based on swivel modules DSM • Integrated rotary potentiometer • Compact design • Wide range of mounting options

Cylinders with displacement encoder

Product range overview



Piston Ø	Stroke/swivel angle [mm/°]	Suitable				
		for positioning with		for end-position controller		for use as a measuring cylinder
		CPX-CMAX	CPX-CMPX	SPC11		
Rodless						
25, 32, 40, 63	100, 160, 225, 300, 360, 450, 500, 600, 750, 850, 1000, 1250, 1500, 1750, 2000	■	■	■	■	
18, 25, 32, 40, 63	100, 160, 225, 300, 360, 450, 500, 600, 750, 850, 1000, 1250, 1500, 1750, 2000	■	■	■	■	
With piston rod						
32, 40, 50, 63	10 ... 2000	-	-	-	■	
	100 ... 750	■	■	■	-	
80, 100	10 ... 2000	-	-	-	■	
	100 ... 750	■	■	■	-	
32, 40, 50, 63, 80	100, 150, 225, 300, 360, 450, 600, 750	■	■	■	■	
Swivel modules						
25, 40, 63	270	■	■	■	■	

Cylinders with displacement encoder

Features



Servopneumatic drive technology

Positioning and Soft Stop applications as an integral component of the valve terminal CPX – the modular peripheral system for decentralised automation tasks.

The modular design means that valves, digital inputs and outputs, positioning modules and end-position controllers, as appropriate to the application, can be combined in almost any way on the CPX terminal.

Advantages:

- Pneumatics and electrics – control and positioning on one platform
- Innovative positioning technology – piston rod drives, rodless drives, rotary drives
- Actuation via fieldbus
- Remote maintenance, remote diagnostics, web server, SMS and e-mail alerts are all possible via TCP/IP
- Modules can be quickly exchanged and expanded without altering the wiring

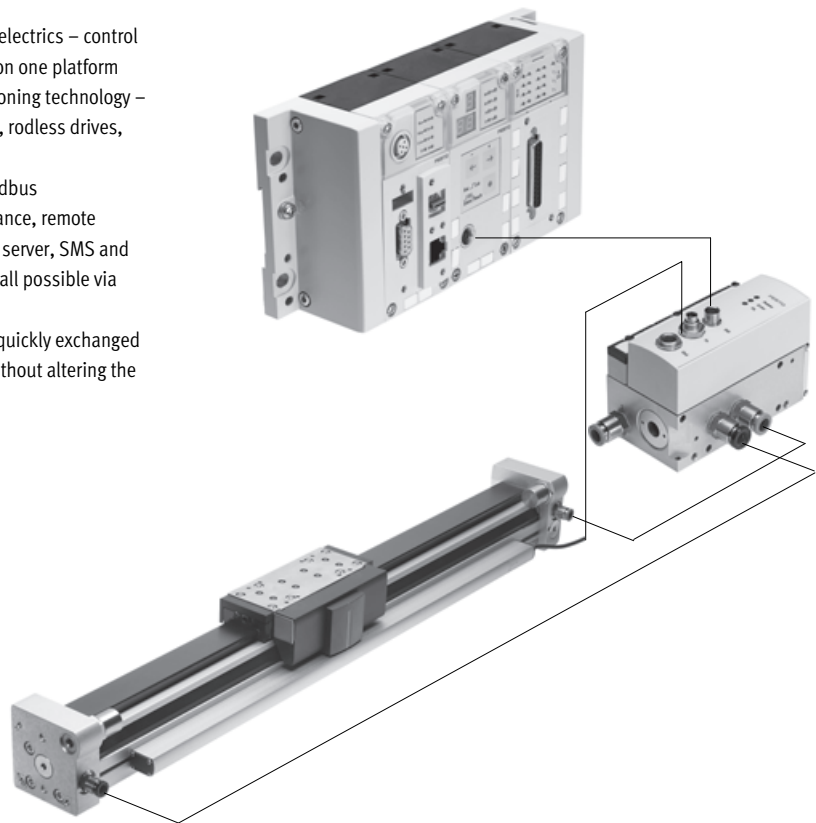

Axis controller CPX-CMAX



Free choice:

Position and force control, directly actuated or selected from one of 64 configurable position sets. If you are looking for something more: the configurable function for switching to the next set enables simple functional sequences to be realised with the axis controller CPX-CMAX.

All stations are recognised as: the auto-identification function identifies each participant with its device data on the controller CPX-CMAX.

Also included:

The functional scope of the controller CPX-CMAX includes actuation of a brake or clamping unit via the proportional directional control valve VPWP.

Up to 8 modules (max. 8 axes) can be operated in parallel and independently of each other. Commissioning via FCT (Festo configuration software) or via fieldbus: no programming, only configuration.

Technical data → Internet: cpx-cmax

Advantages:

- Greater flexibility
- OEM friendly – commissioning also via fieldbus
- Easy installation and fast commissioning
- Cost-effective
- You program the system in your PLC environment

Cylinders with displacement encoder

Features

FESTO

End-position controller CPX-CMPX



Fast travel between the mechanical end stops of the cylinder, stopping gently and without impact in the end position.
Fast commissioning via control panel, fieldbus or handheld unit. Improved control of downtime. Actuation of a brake or clamping unit via the proportional directional control valve VPWP is an integral part of the controller CMPX.

Depending on the fieldbus chosen, up to 9 end-position controllers can be actuated on the CPX terminal. All system data can be read and written via the fieldbus, including, for example, the mid positions.

Technical data → Internet: [cpx-cmpx](#)

Advantages:

- Greater flexibility
- OEM friendly – commissioning also via fieldbus
- Easy installation and fast commissioning
- Cost-effective
 - up to 30% faster cycle rates
 - significantly reduced system vibration
- Improved work ergonomics thanks to significantly reduced noise level
- The extended diagnostics help to reduce the service time of the machine

Proportional directional control valve VPWP



The 5/3-way proportional directional control valve for applications with Soft Stop and pneumatic positioning. Fully digitalised – with integrated pressure sensors, with new diagnostic functions. In sizes 4, 6, 8 and 10. Flow rate of 350, 700, 1400 and 2000 l/min.

With switching output for actuating a brake. Coloured supply ports. Pre-assembled cables guarantee faultless and fast connection with the controllers CPX-CMPX and CPX-CMAX.

Technical data → Internet: [vpwp](#)

Advantages:

- Easy installation and fast commissioning
- Reduction of system downtimes thanks to the new diagnostic options
- With switching output for actuating a brake/clamping unit

Measuring module CPX-CMIX



Fully digital data acquisition and transmission means that pneumatic cylinders can be used as sensors. With very high repetition accuracy and incorporating both analogue and digital measuring sensors.

Suitable for the linear drive DGCI with displacement encoder for measuring absolute values, for the piston rod drive DNCI/DDPC with incremental displacement encoder or even for a potentiometer of the type MLO.

Technical data → Internet: [cpx-cmix](#)

Advantages:

- All process steps can be documented, which improves quality
- An adjustable contact force (via pressure regulator) increases the precision of the "displacement sensor"
- With displacement encoders for measuring absolute values, the actual position is immediately available after the system is switched on

Cylinders with displacement encoder

Drive options

FESTO

System with linear drive DDLI, DGCI

Technical data → Internet: [ddli](#) or [dgci](#)

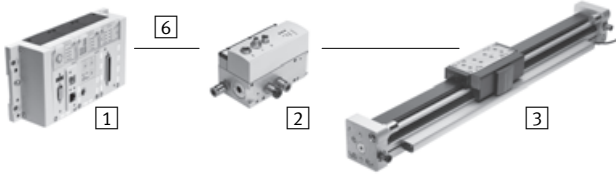

- 1 Controller module CPX-CMPX or CPX-CMAX
- 2 Proportional directional control valve VPWP
- 3 Linear drive DDLI, DGCI with displacement encoder
- 6 Connecting cable KVI-CP-3...

- Pneumatic rodless linear drive with displacement encoder, with or without recirculating ball bearing guide
- Displacement encoder with absolute and contactless measurement
- Diameters:
 - DGCI: 18 ... 63 mm
 - DDLI: 25 ... 63 mm
- Stroke: 100 ... 2000 mm in fixed lengths
- Range of applications: Soft Stop and pneumatic positioning
- Loads from 1 ... 180 kg
- No sensor interface required

Advantages:

- Complete drive unit
- DDLI for easy connection to customer's guide system
- Excellent running characteristics
- For fast and accurate positioning down to ± 0.2 mm (only with axis controller CPX-CMAX)

System with standard cylinder DNCI, DDPC

Technical data → Internet: [dnci](#)

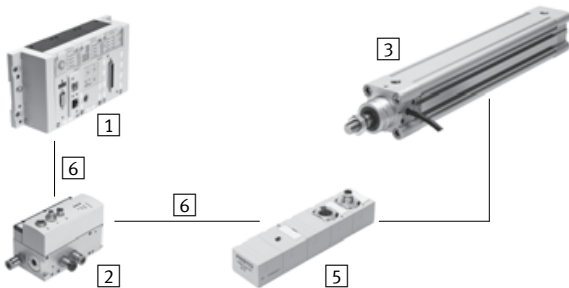

- 1 Controller module CPX-CMPX or CPX-CMAX
- 2 Proportional directional control valve VPWP
- 3 Standard cylinder DNCI, DDPC with displacement encoder
- 5 Sensor interface CASM-S-D3-R7
- 6 Connecting cable KVI-CP-3...

- Standard cylinder with integrated displacement encoder, conforms to DIN ISO 6432, VDMA 24 562, NF E 49 003.1 and Uni 10 290
- Displacement encoder with contactless and incremental measuring
- Diameter: 32 ... 100 mm
- Stroke: 100 ... 750 mm
- Range of applications: Soft Stop and pneumatic positioning
- Loads from 3 ... 450 kg and a matching sensor interface CASM-S-D3-R7
- Pre-assembled cables guarantee faultless and fast electrical connection

Advantages:

- Compact drive unit
- Can be used universally
- Also with guide unit
- For fast and accurate positioning up to ± 0.5 mm (only with axis controller CPX-CMAX)

Cylinders with displacement encoder

Drive options

System with swivel module DSMI

Technical data → Internet: [dsmi](#)

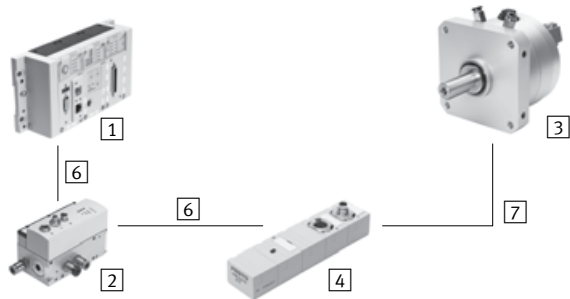

- 1 Controller module CPX-CMPX or CPX-CMAX
- 2 Proportional directional control valve VPWP
- 3 Swivel module DSMI with displacement encoder
- 4 Sensor interface CASM-S-D2-R3
- 6 Connecting cable KVI-CP-3-...
- 7 Connecting cable NEBC-P1W4-K-0,3-N-M12G5

- Swivel module DSMI with integrated displacement encoder
- Identical design to pneumatic swivel module DSM
- Absolute displacement encoder based on a potentiometer
- Swivel range of 0 ... 270°
- Size: 25, 40, 63
- Max. torque: 5 ... 40 Nm
- Range of applications: Soft Stop and pneumatic positioning
- Mass moments of inertia from 15 ... 6000 kgcm² and a matching sensor interface CASM-S-D2-R3
- Pre-assembled cables guarantee faultless and fast connection with the proportional directional control valve VPWP

- Advantages:
- Complete drive unit, compact, can be used immediately
 - High angular acceleration
 - With adjustable fixed stops
 - For fast and accurate positioning down to ±0.2° (only with axis controller CPX-CMAX)

System with potentiometer

Technical data → Internet: [casm](#)

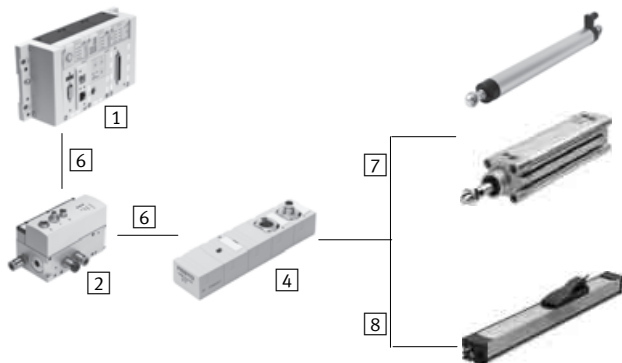

- 1 Controller module CPX-CMPX or CPX-CMAX
- 2 Proportional directional control valve VPWP
- 4 Sensor interface CASM-S-D2-R3
- 6 Connecting cable KVI-CP-3-...
- 7 Connecting cable NEBC-P1W4-K-0,3-N-M12G5
- 8 Connecting cable NEBC-A1W3-K-0,4-N-M12G5

- Attachable potentiometers with absolute measurement, with high degree of protection
- With connecting rod or moment compensator
- Measuring range:
Connecting rod: 100 ... 750 mm
Moment compensator: 225 ... 2000 mm
- Pre-assembled cables guarantee faultless and fast connection with the sensor interface CASM
- Range of applications: Soft Stop and pneumatic positioning with cylinder Ø 25 ... 80 mm, e.g. DNC or DSBC
- Loads from 1 ... 300 kg

- Advantages:
- Easy installation and fast commissioning
 - Cost-effective
 - Can also be used in harsh ambient conditions
 - Variety of drives: CPX-CMPX and CPX-CMAX also support cylinders with external displacement encoder

Cylinders with displacement encoder

Drive options

System components for Soft Stop systems with end-position controller CPX-CMPX						
	Linear drive	Standard cylinder	Swivel module	Displacement encoder		→ Page/ Internet
	DDLI/DGCI	DNCI, DDPC	DSMI	MLO-LWG/-TLF	MME-MTS	
End-position controller CPX-CMPX	■	■	■	■	■	cmpx
Prop. directional control valve VPWP	■	■	■	■	■	vpwp
Sensor interface CASM-S-D2-R3	-	-	■	■	-	casm
Sensor interface CASM-S-D3-R7	-	■	-	-	-	casm
Connecting cable KVI-CP-3-...	■	■	■	■	■	kvi
Connecting cable NEBC-P1W4-...	-	-	■	■ / -	-	nebc
Connecting cable NEBC-A1W3-...	-	-	-	- / ■	-	nebc
Connecting cable NEBP-M16W6-...	-	-	-	-	■	vpwp

System components for pneumatic positioning systems with axis controller CPX-CMAX						
	Linear drive	Standard cylinder	Swivel module	Displacement encoder		→ Page/ Internet
	DDLI/DGCI	DNCI, DDPC	DSMI	MLO-LWG/-TLF	MME-MTS	
Axis controller CPX-CMAX	■	■	■	■	■	cmax
Prop. directional control valve VPWP	■	■	■	■	■	vpwp
Sensor interface CASM-S-D2-R3	-	-	■	■	-	casm
Sensor interface CASM-S-D3-R7	-	■	-	-	-	casm
Connecting cable KVI-CP-3-...	■	■	■	■	■	kvi
Connecting cable NEBC-P1W4-...	-	-	■	■ / -	-	nebc
Connecting cable NEBC-A1W3-...	-	-	-	- / ■	-	nebc
Connecting cable NEBP-M16W6-...	-	-	-	-	■	vpwp

System components for measuring cylinders with measuring module CPX-CMIX						
	Linear drive	Standard cylinder	Swivel module	Displacement encoder		→ Page/ Internet
	DDLI/DGCI	DNCI, DDPC	DSMI	MLO-LWG/-TLF	MME-MTS	
Measuring module CPX-CMIX-M1-1	■	■	■	■	■	cmix
Sensor interface CASM-S-D2-R3	-	-	■	■	-	casm
Sensor interface CASM-S-D3-R7	-	■	-	-	-	casm
Connecting cable KVI-CP-3-...	(■) ¹⁾	■	■	■	(■)	kvi
Connecting cable NEBC-P1W4-...	-	-	■	■ / -	-	nebc
Connecting cable NEBC-A1W3-...	-	-	-	- / ■	-	nebc
Connecting cable NEBP-M16W6-...	-	-	-	-	■	vpwp

1) As an extension

Cylinders with displacement encoder

Overview

Individual components for positioning With end-position controller SPC11

→ Internet: [spc11](#)

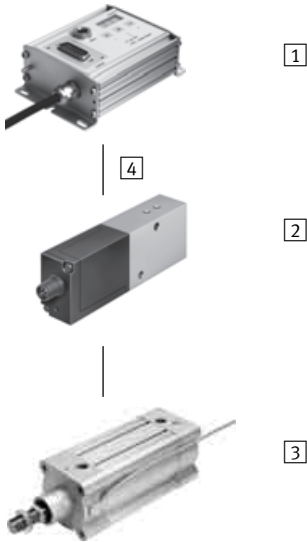

- 1 End-position controller SPC11-INC
- 2 Proportional directional control valve MPYE
- 3 Standard cylinder DNCI, DDPC
- 4 Connecting cable KMPYE-AIF-...

Individual components for use as a measuring cylinder With measuring module CPX-CMIX

→ Internet: [cmix](#)

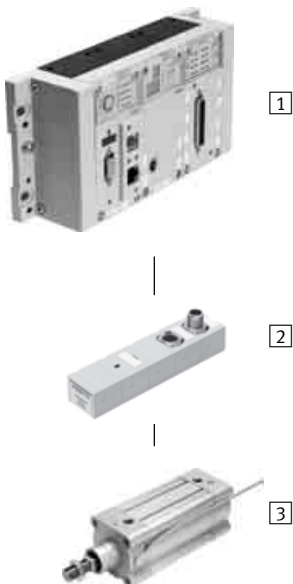

- 1 Measuring module CPX-CMIX
- 2 Sensor interface CASM-S-D3-R7
- 3 Standard cylinder DNCI, DDPC

With measured-value transducer DADE

→ Internet: [dade](#)

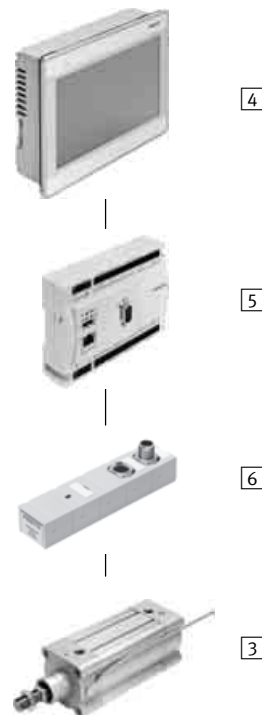

- 3 Standard cylinder DNCI, DDPC
- 4 Operator unit CDPX
- 5 Controller CECC
- 6 Measured-value transducer DADE

Standard cylinders DDP, integrated displacement encoder

Peripherals overview

FESTO

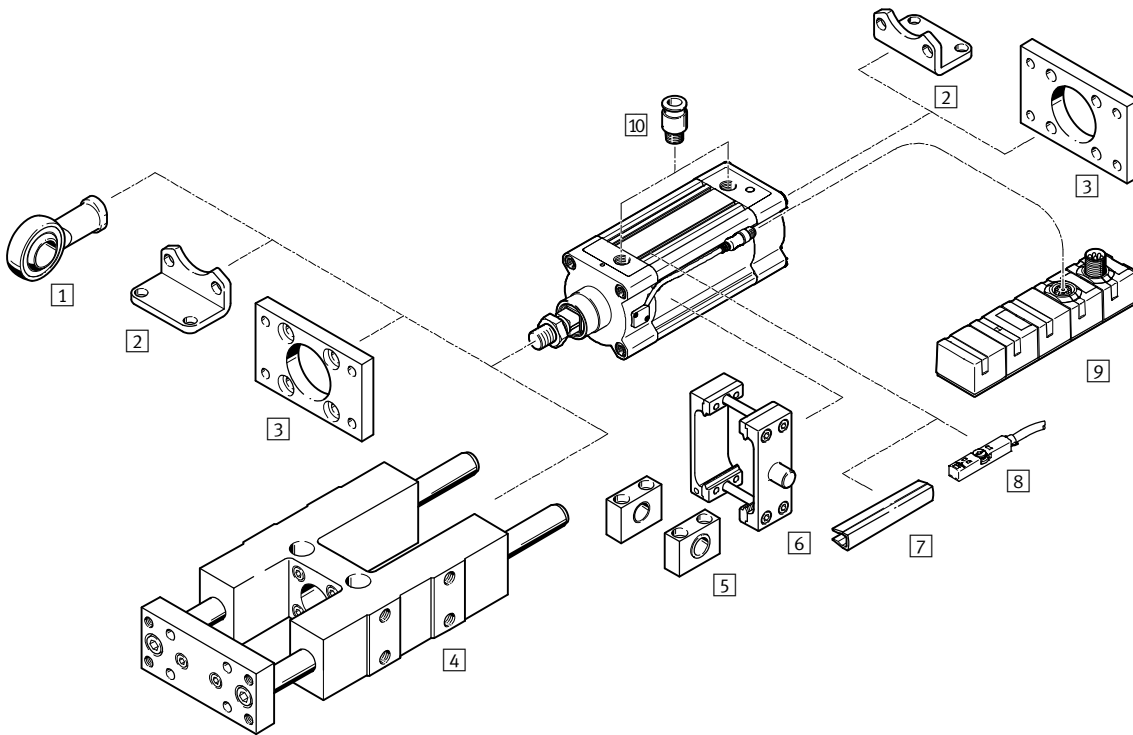

-  - Note

If the drive DDP is used without an end-position controller CPX-CMPX, SPC11 or axis controller CPX-CMAX, e.g. as a measuring cylinder, then the standard accessories for the drive DNC can be used.

Standard cylinders DDPC, integrated displacement encoder

Peripherals overview

Accessories		
Type	Description	→ Page/Internet
1 Rod eye SGS	With spherical bearing	22
2 Foot mounting HNC	For mounting the drive on the bearing and end cap	22
3 Flange mounting FNC	For mounting the drive on the bearing and end cap	22
4 Guide unit ¹⁾ FENG-KF	For protecting against rotation at high torque loads	20
5 Trunnion support LNZG	For securing the trunnion mounting kit DAMT	24
6 Trunnion mounting kit DAMT	For swivelling movements of the drive	23
7 Slot cover ABP-5-S	For protecting against the ingress of dirt	24
8 Proximity sensor SME/SMT-8	For additional sensing of the piston position, can be ordered optionally, only in combination with the order code A in the modular products section for the drive	sm
9 Sensor interface CASM	Used to connect pneumatic drives with analogue/incremental displacement encoder to a position controller CPX-CMAX or CPX-CMPX	casm
10 Push-in fitting QS	For connecting compressed air tubing with standard O.D.	24

1) Guide unit FENG-KF must be attached to the piston rod in a way that eliminates backlash

 Note
Allocation table of drives and associated proportional directional control valves → page 25

Standard cylinders DDP, integrated displacement encoder

Type codes

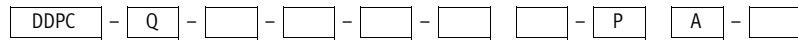

Type	
DDP	Standard cylinder

Protection against rotation	
Q	With protection against rotation

Piston Ø [mm]	
---------------	--

Stroke [mm]	
-------------	--

Guide unit	
-	None
D	Attached

Clamping unit	
-	None
C	Attached

Piston rod type	
-	At one end
T	Through piston rod

Cushioning	
P	Elastic cushioning rings/pads at both ends

Position sensing	
A	Via proximity sensor



Piston rod extension	
-	None
...E	1 ... 500 mm

Standard cylinders DDPC, integrated displacement encoder

Technical data

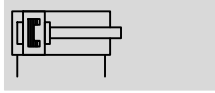
Function



-  - Diameter
80 and 100 mm
-  - Stroke length
10 ... 2000 mm



General technical data		
Piston \varnothing	80	100
Based on standard	ISO 15552	
Design	Piston	
	Piston rod	
	Profile barrel	
Mode of operation	Double-acting	
Guide ¹⁾	Guide rod with yoke, with ball bearing guide	
Protection against rotation	Square piston rod	
Mounting position	Any	
Type of mounting	Via accessories	
Cushioning	Elastic cushioning rings/pads at both ends	
Position sensing	Integrated displacement encoder	
	Via proximity sensor ²⁾	
Measuring principle (displacement encoder)	Encoder, non-contacting and relative measurement	
Pneumatic connection	G3/8	G1/2
Stroke		
DDPC-... ³⁾	[mm]	10 ... 2000
DDPC-...-D	[mm]	100 ... 500
Extended piston rod	[mm]	1 ... 500

- 1) Guide unit FENG-KF can be ordered via the modular product system (feature D) and is supplied attached. The maximum stroke is restricted.
- 2) Not included in the scope of delivery, can be ordered as an option
- 3) Can only be used without restriction as a positioning drive in the range from 100 ... 750 mm.
Note stroke reduction in combination with CPX-CMAX

Operating and environmental conditions		
Operating pressure	[bar]	4 ... 12
Operating pressure ¹⁾	[bar]	4 ... 8
Operating medium ²⁾	Compressed air to ISO 8573-1:2010 [6:4:4]	
Note on operating/pilot medium	Operation with lubricated medium not possible	
	Pressure dew point 10 °C below ambient/medium temperature	
Ambient temperature ³⁾	[°C]	-20 ... +80
Vibration resistance to DIN/IEC 68 Part 2-6	Severity level 2	
Continuous shock resistance to DIN/IEC 68 Part 2-82	Severity level 2	
CE mark (see declaration of conformity) ⁴⁾	To EU EMC Directive	
Corrosion resistance class CRC ⁵⁾	1	

- 1) Only applies to applications with end-position controller CPX-CMPX, SPC11 and axis controller CPX-CMAX
- 2) Characteristic values contingent on the proportional directional control valve VPWP, MPYE
- 3) Note operating range of proximity sensors
- 4) For information about the applicability of the component see the manufacturer's EC declaration of conformity at: www.festo.com/sp → User documentation.
If the component is subject to restrictions on usage in residential, office or commercial environments or small businesses, further measures to reduce the emitted interference may be necessary.
- 5) Corrosion resistance class CRC 1 to Festo standard FN 940070
Low corrosion stress. For dry indoor applications or transport and storage protection. Also applies to parts behind covers, in the non-visible interior area, and parts which are covered in the application (e.g. drive trunnions).

Standard cylinders DDP, integrated displacement encoder

Technical data

Forces [N] and impact energy [Nm]		
Piston Ø	80	100
Theoretical force at 6 bar, advancing	3016	4712
Theoretical force at 6 bar, retracting	2721	4418
Impact energy at the end positions	1.8	2.5

Permissible impact velocity:

$$v_{perm.} = \sqrt{\frac{2 \times E_{perm.}}{m_{dead} + m_{load}}}$$

$v_{perm.}$ Permissible impact velocity
 $E_{perm.}$ Max. impact energy
 m_{dead} Moving load (drive)
 m_{load} Moving effective load

 Note
 These specifications represent the maximum values that can be achieved. Note the maximum permissible impact energy.

Maximum permissible load:

$$m_{load} = \frac{2 \times E_{perm.}}{v^2} - m_{dead}$$

Positioning characteristics with axis controller CPX-CMAX		
Piston Ø	80	100
Stroke	[mm]	100 ... 750
Mounting position		Any
Resolution	[mm]	0.01
Repetition accuracy	[mm]	≤ ±0.5
Min. load, horizontal	[kg]	20
Max. load, horizontal	[kg]	300
Min. load, vertical ¹⁾	[kg]	20
Max. load, vertical ¹⁾	[kg]	100
Min. travel speed	[m/s]	0.05
Max. travel speed	[m/s]	1
Typical positioning time, long stroke ²⁾	[s]	0.88/1.02
Typical positioning time, short stroke ³⁾	[s]	0.77/0.95
Min. positioning stroke ⁴⁾	[mm]	≤ 3
Stroke reduction ⁵⁾	[mm]	15
Recommended proportional directional control valve		
For CPX-CMAX	→ page 25	

- 1) Only in combination with external guide
- 2) At 6 bar, horizontal mounting position, DDP-XX-500, 400 mm positioning travel at min./max. load
- 3) At 6 bar, horizontal mounting position, DDP-XX-500, 200 mm positioning travel at min./max. load
- 4) Refers to the cylinder stroke, but not more than 10 mm
- 5) The stroke reduction must be maintained on each side of the drive, the max. positionable stroke is therefore: stroke – 2x stroke reduction

Force control characteristics with axis controller CPX-CMAX		
Piston Ø	80	100
Stroke	[mm]	100 ... 750
Mounting position		Any
Max. controllable force ¹⁾	[N]	2710/2440
Typical friction forces ²⁾	[N]	140
Repetition accuracy pressure regulation ³⁾⁴⁾	[%]	< ±2

- 1) Advancing/retracting at 6 bar
- 2) These values can fluctuate greatly from cylinder to cylinder and are not guaranteed.
 These friction forces must also be taken into consideration when using an external guide or when the cylinder is moving other components subject to friction
- 3) This value defines the repetition accuracy with which the internal differential pressure in the cylinder is controlled and refers to the maximum controllable force (the internal differential pressure corresponds to the prescribed force setpoint value)
- 4) The effective force at the workpiece and its accuracy depends largely on the friction in the system as well as the repetition accuracy of the internal control system. Note that friction forces always work against the direction of movement of the piston. The following formula can be used as a rule of thumb for the force F at the workpiece:
 $F = F_{setpoint} \pm F_{friction\ forces} \pm \text{internal repetition accuracy}$

Standard cylinders DDPC, integrated displacement encoder

Technical data

Positioning characteristics with Soft Stop end-position controller CPX-CMPX, SPC11			
Piston \varnothing		80	100
Stroke	[mm]	100 ... 750	
Mounting position		Any	
Repetition accuracy	[mm]	± 2	
Min. load, horizontal	[kg]	20	32
Max. load, horizontal	[kg]	300	450
Min. load, vertical ¹⁾	[kg]	20	32
Max. load, vertical ¹⁾	[kg]	100	150
Travel time	[s]	→ Soft Stop sizing software: → www.festo.com	
Recommended proportional directional control valve			
For CPX-CMPX		→ page 25	
For SPC11		→ page 25	

1) Only in combination with external guide

Electrical data – Displacement encoder			
Output signal		Analogue	
Independent linearity			
Strokes up to 500 mm	[mm]	$< \pm 0.08$	
Strokes up to 1000 mm	[mm]	$< \pm 0.09$	
Strokes above 1000 mm	[mm]	$< \pm 0.11$	
Max. travel speed	[m/s]	1.5	
Protection class		IP65	
CE marking (see declaration of conformity)		In accordance with EU EMC Directive ¹⁾	
Max. permitted magnetic disruption field ²⁾	[kA/m]	10	
Electrical connection		Cable with 8-pin plug, round type M12	
Cable length	[m]	1.5	

1) For information about the applicability of the component see the manufacturer's EC declaration of conformity at: www.festo.com/sp → User documentation.
If the component is subject to restrictions on usage in residential, office or commercial environments or small businesses, further measures to reduce the emitted interference may be necessary.

2) At 100 mm interval

Pin assignment of plug

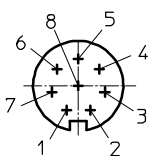

Pin	Function	Colour
1	5 V	Black
2	GND	Brown
3	sin+	Red
4	sin-	Orange
5	cos-	Green
6	cos+	Yellow
7	Screening	Screened
8	n.c.	-

Standard cylinders DDP, integrated displacement encoder

Technical data

Weight [g]		
Piston Ø	80	100
DDPC-...		
Basic weight with 0 mm stroke	3053	4330
Additional weight per 10 mm stroke	87	95
Moving load with 0 mm stroke	804	994
Additional weight per 10 mm stroke	31	31
DDPC-...-T – Through piston rod		
Basic weight with 0 mm stroke	3537	5019
Additional weight per 10 mm stroke	127	134
Moving load with 0 mm stroke	1247	1467
Additional weight per 10 mm stroke	70	70
DDPC-...-E – Additional weight with piston rod extension		
Additional weight per 10 mm extension	31	31
DDPC-...-C – Additional weight with clamping unit		
Additional weight	2046	2829
DDPC-...-D – Additional weight with guide unit		
Basic weight with 0 mm stroke	10430	12990
Additional weight per 10 mm stroke	80	80

Materials

Sectional view

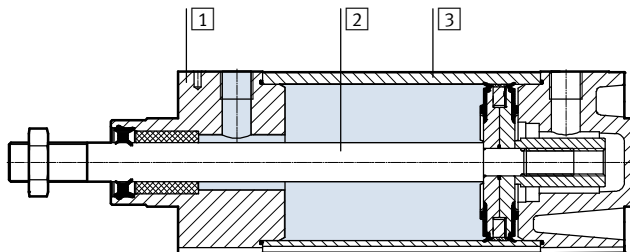

Standard cylinder		
1	End cap	Wrought aluminium alloy
2	Piston rod	High-alloy steel
3	Cylinder barrel	Wrought aluminium alloy
-	Seals	NBR, polyurethane
	Note on materials	Free of copper and PTFE RoHS-compliant

Standard cylinders DDPC, integrated displacement encoder

Technical data

Torques and lateral forces

Max. torque for protection against rotation

Dynamic $\leq 3 \text{ Nm}$

Static $\leq 5 \text{ Nm}$

An external guide unit FENG-KF is recommended with higher torque loads.

The guide unit is supplied attached.

The permissible static and dynamic characteristic load values with and without attached guide

→ Internet: feng

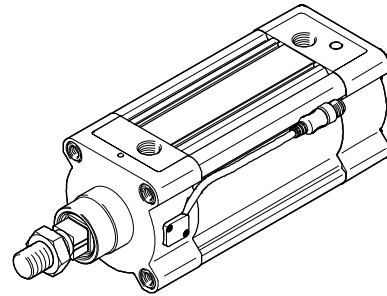

Mounting conditions

When mounting a drive A with magnet (for position sensing) next to a standard cylinder DDPC, the following conditions must be observed:

X Minimum distance between the drives

Y Offset between the drives on the bearing cap

Parallel assembly

If the offset $Y = 0 \text{ mm}$, the drives can be assembled directly next to one another.

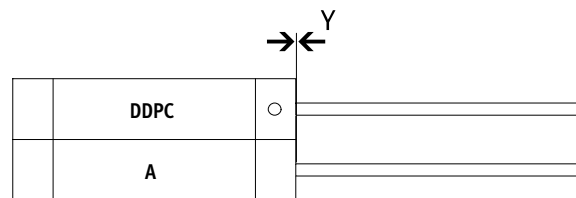

Offset assembly, cable outlet between the drives

If the offset is $Y > 0 \text{ mm}$ and the cable outlet is between the drives, a distance of $X > 70 \text{ mm}$ must be observed.

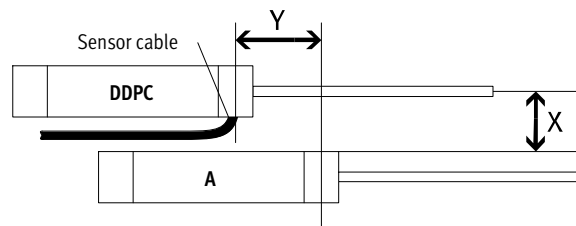

Offset assembly, cable outlet upwards or downwards

If the offset is $Y > 0 \text{ mm}$ and the cable outlet is up or down, a distance of $X > 60 \text{ mm}$ must be observed.

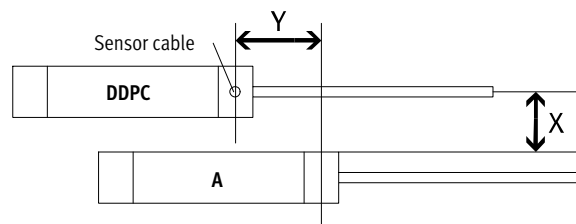

Standard cylinders DDPG, integrated displacement encoder

Technical data

FESTO

Dimensions

Download CAD data → www.festo.com

DDPG-...

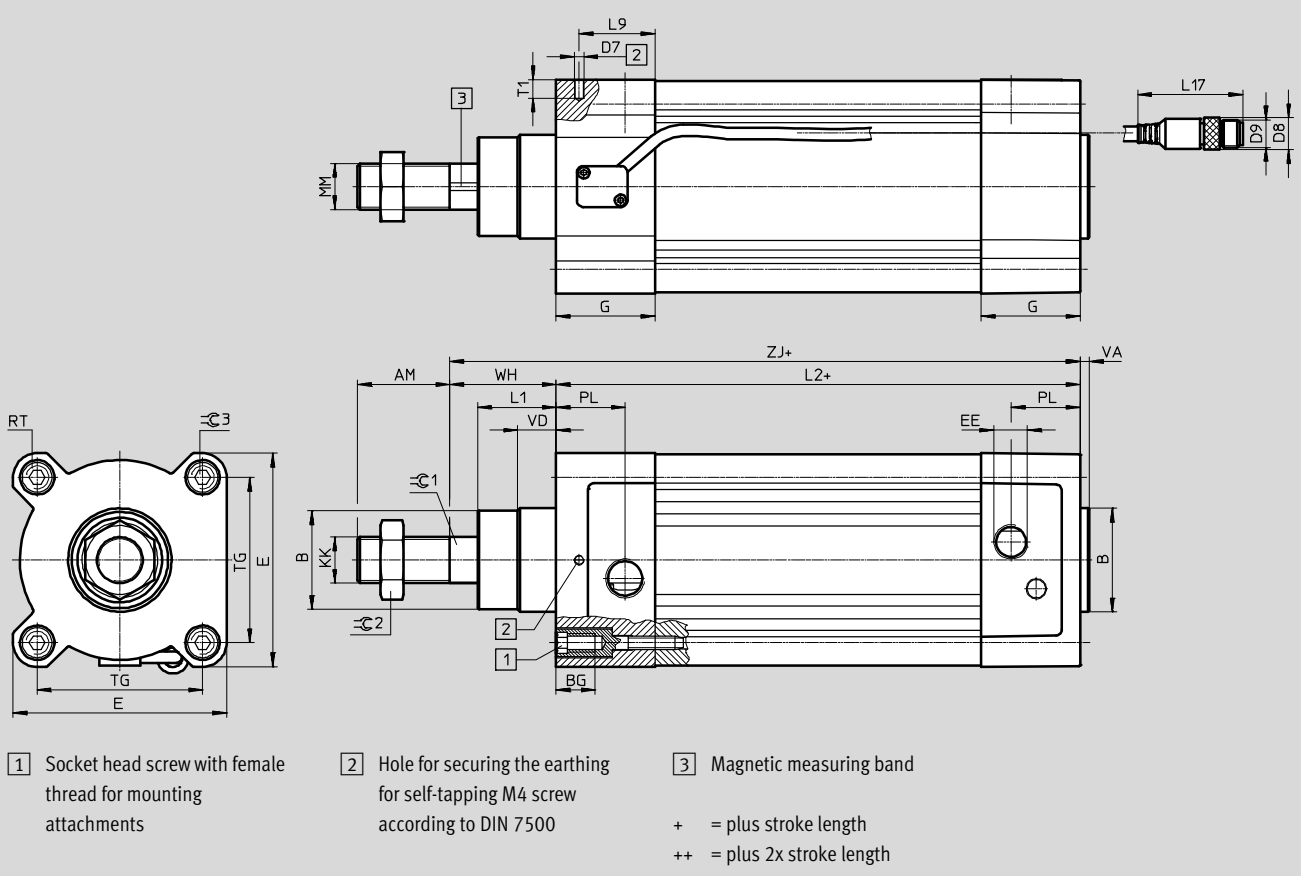

∅	AM	B	BG	D7	D8	D9	E	EE	G
[mm]		∅ d11		∅	∅				
80	40	45	17	3.7	14	M12	93	G3/8	43
100	40	55	17	3.7	14	M12	110	G1/2	48

∅	KK	L1	L2	L9	L17	MM	PL	RT	T1
[mm]						∅			
80	M20x1.5	34.2	128	20	45.7	20	30	M10	8
100	M20x1.5	38	138	21.5	45.7	20	31.5	M10	8

∅	TG	VA	VD	WH	ZJ	∅ 1	∅ 2	∅ 3
[mm]								
80	72	4	16.7	46	174	22	30	6
100	89	4	20.5	51	189	22	30	6

Standard cylinders DDP, integrated displacement encoder

Technical data

Dimensions

Download CAD data → www.festo.com

DDPC-...-T – Through piston rod

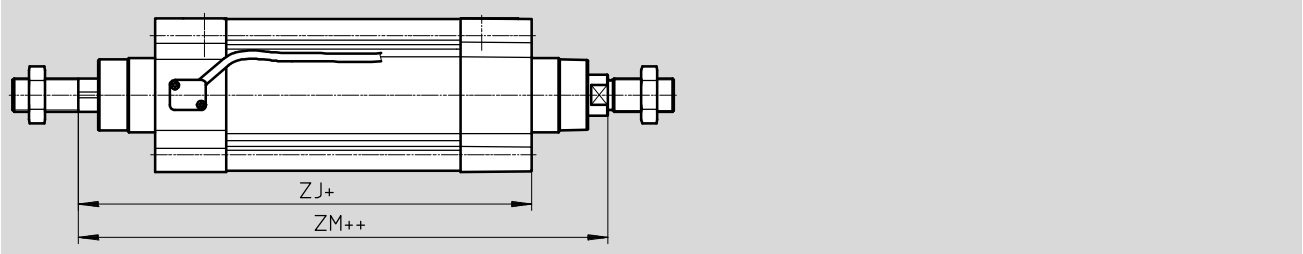

DDPC-...-CT – Through piston rod with clamping unit

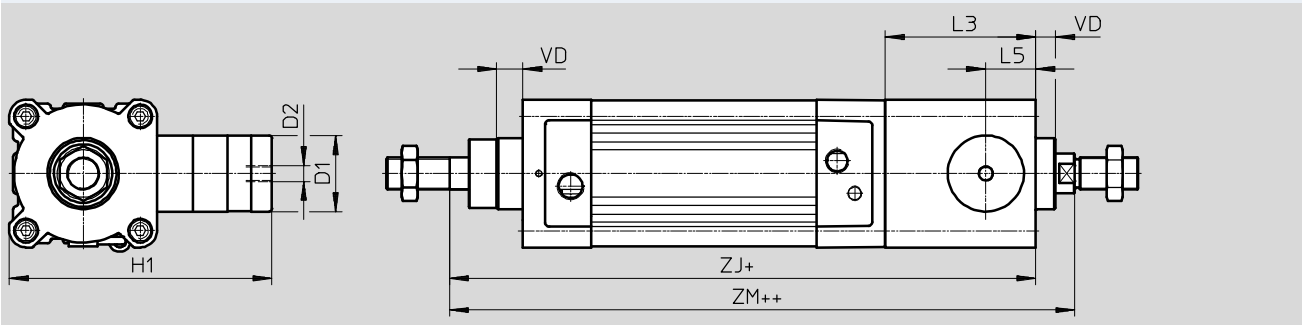

DDPC-...-E – Extended piston rod

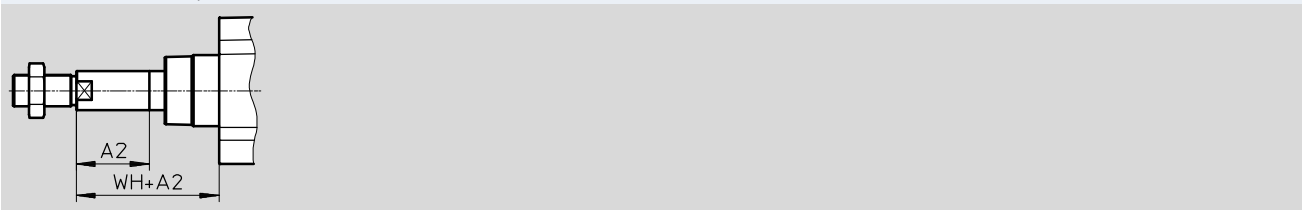

∅	A2	D1	D2	H1	L3	L5
[mm]	max.	∅ f9				
80	500	48	G1/8	165.5	95	31.5
100	500	48	G1/8	174	98	31

∅	VD	WH	ZJ		ZM	
			DDPC-...-T	DDPC-...-CT	DDPC-...-T	DDPC-...-CT
[mm]						
80	16.7	46	174	269	222	317
100	20.5	51	189	287	240	338

Standard cylinders DDPG, integrated displacement encoder

Technical data

Dimensions Download CAD data → www.festo.com

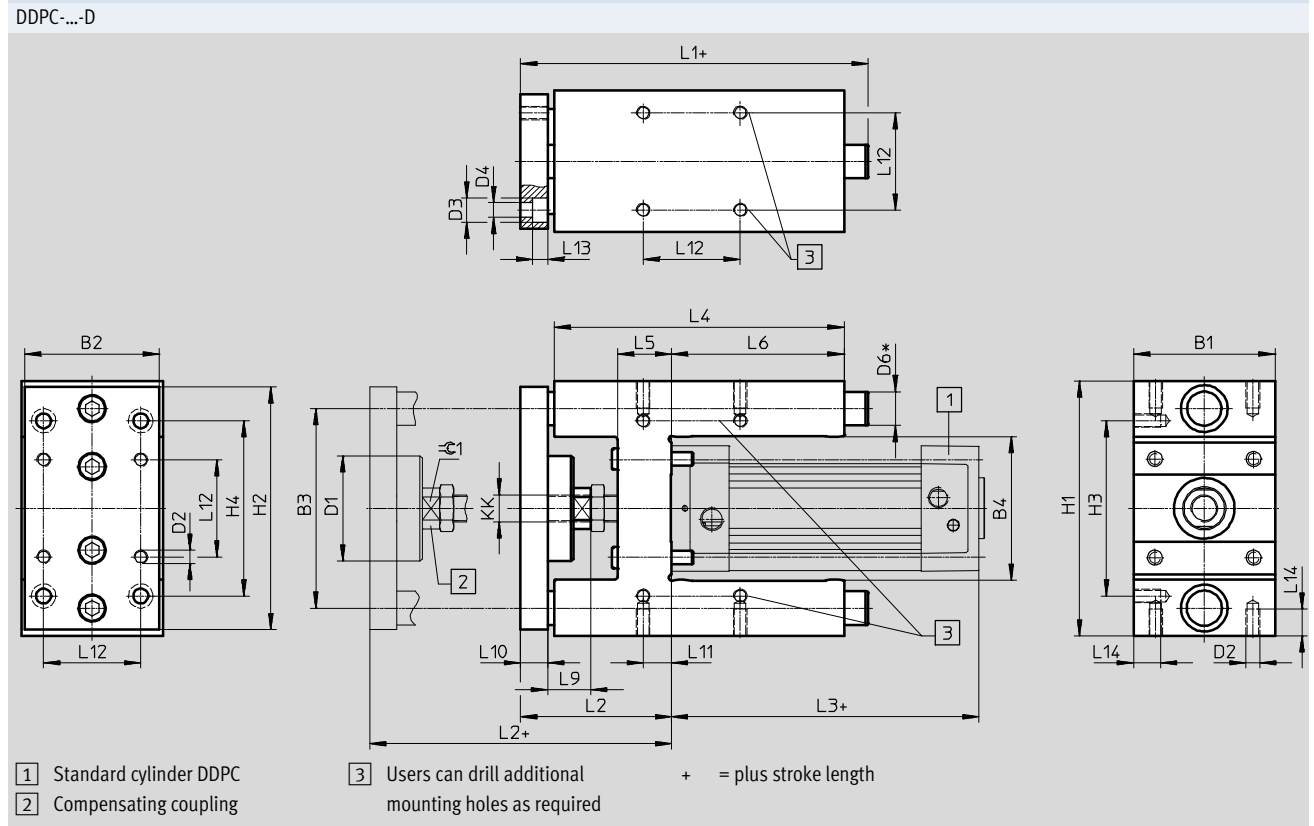

∅	B1	B2	B3	B4	D1	D2	D3	D4	D6
[mm]	-0.3		±0.2	±0.6	∅		∅	∅	∅
80	105	100	148	106	78	M10	18	11	25
100	130	120	172	131	78	M10	18	11	25

∅	H1	H2	H3	H4	KK	L1	L2	L3	L4
[mm]	-0.5		±0.2	±0.2			+10		
80	189	180	130	130	M20x1.5	258	111	194	215
100	213	200	150	150	M20x1.5	263	116	138	220

∅	L5	L6	L9	L10	L11	L12	L13	L14	∅ 1
[mm]						±0.2			
80	40	128	32	20	21	72	11	20	27
100	40	128	32	20	24.5	89	11	20	27

Standard cylinders DDP, integrated displacement encoder

Ordering data – Modular products

Ordering table					
Piston Ø	80	100	Condi- tions	Code	Enter code
M Module No.	1677705	1691433			
Function	Standard cylinder with integrated displacement encoder			DDPC	DDPC
Protection against rotation	With protection against rotation			-Q	-Q
Piston Ø [mm]	80	100		-...	
Stroke [mm]	10 ... 2000		1	-...	
O Guide unit	None				
	Attached			-D	
Clamping unit	None				
	Attached		2	-C	
Piston rod type	At one end				
	Through piston rod			T	
M Cushioning	Elastic cushioning rings/pads at both ends			-P	-P
Position sensing	Via proximity sensor			A	A
O Piston rod extension	None				
	[mm]	1 ... 500		-...E	

- 1** -... Can only be used without restriction as a positioning drive in the range from 100 ... 750 mm
- 2** **C** Only available with T

M Mandatory data
O Options

Transfer order code

Standard cylinders DDPC, integrated displacement encoder

Accessories



Foot mounting HNC

Materials:
Galvanised steel
Free of copper and PTFE

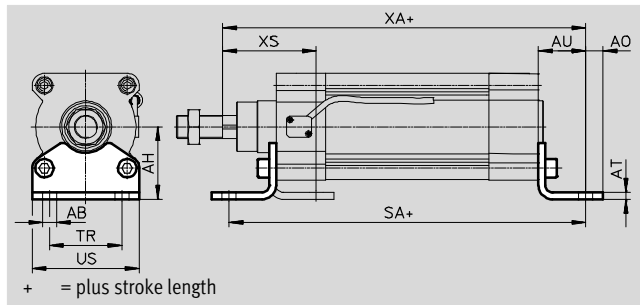

Dimensions and ordering data							
For \varnothing	AB \varnothing	AH	AO	AT	AU	SA	
[mm]						DDPC-...	DDPC-...-C
80	12	63	15	6	41	276	371
100	14.5	71	17.5	6	41	220	318

For \varnothing	TR	US	XA		XS	CRC ¹⁾	Weight	Part No.	Type
[mm]			DDPC-...	DDPC-...-C			[g]		
80	63	93	281	376	81	2	829	174373	HNC-80
100	75	110	230	328	86	2	1009	174374	HNC-100

1) Corrosion resistance class CRC 2 to Festo standard FN 940070
Moderate corrosion stress. Indoor applications in which condensation may occur. External visible parts with primarily decorative requirements for the surface and which are in direct contact with the ambient atmosphere typical for industrial applications.

Flange mounting FNC

Materials:
FNC: Galvanised steel
Free of copper and PTFE
RoHS-compliant

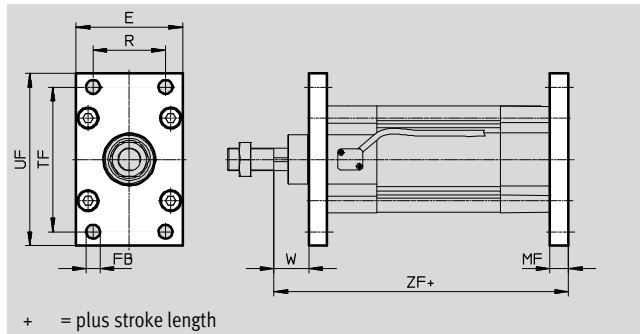

Dimensions and ordering data													
For \varnothing	E	FB \varnothing H13	MF	R	TF	UF	W	ZF		CRC ¹⁾	Weight	Part No.	Type
[mm]								DDPC-...	DDPC-...-C		[g]		
80	93	12	16	63	126	150	30	256	351	1	1495	174380	FNC-80
100	110	14	16	75	150	175	35	205	303	1	2041	174381	FNC-100

1) Corrosion resistance class CRC 1 to Festo standard FN 940070
Low corrosion stress. For dry indoor applications or transport and storage protection. Also applies to parts behind covers, in the non-visible interior area, and parts which are covered in the application (e.g. drive trunnions).

Standard cylinders DDPC, integrated displacement encoder

Accessories

Rod eye SGS

Scope of delivery:

1 rod eye, 1 hex nut to DIN 439

Materials:

Galvanised steel

RoHS-compliant

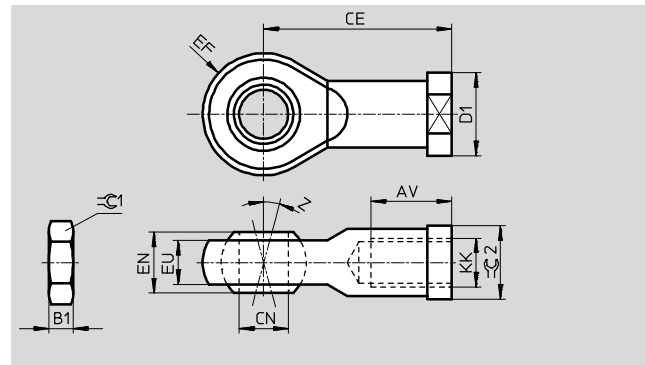

Dimensions and ordering data														Weight	Part No.	Type
For Ø	AV	B1	CE	CN	D1	EF	EN	EU	Z	≈C1	≈C2	CRC ^{1) 2)}				
[mm]				∅ H7	∅	±0.5			[°]				[g]			
M20x1.5	33 -2	10	77	20	34	25	25	18	15	30	30	1	464	9264	SGS-M20x1,5	

1) Corrosion resistance class CRC 1 to Festo standard FN 940070

Low corrosion stress. For dry indoor applications or transport and storage protection. Also applies to parts behind covers, in the non-visible interior area, and parts which are covered in the application (e.g. drive trunnions).

2) The following applies for the ball:

Corrosion resistance class CRC 0 to Festo standard FN 940070

No corrosion stress. Applies to small, optically irrelevant standard parts such as threaded pins, circlips and clamping sleeves which are usually only available in a phosphated or burnished version (and possibly oiled) as well as to ball bearings (for components < CRC 3) and plain bearings.

Trunnion mounting kit DAMT

The mounting kit can be attached at any position along the profile barrel of the cylinder.

Materials:

Galvanised steel

Free of copper and PTFE

RoHS-compliant

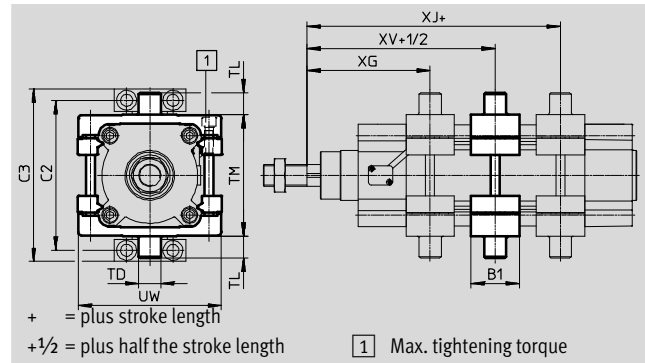

Dimensions and ordering data									
For Ø	B1	C2	C3	TD	TL	TM	UW	XG	
[mm]				∅ e9				DDPC-...	DDPC-...-C
80	44	136	156	20	20	110	130	111	206
100	48	164	189	25	25	132	145	123	221

For Ø	XJ		XV		Max. tightening torque	CRC ¹⁾	Weight	Part No.	Type
[mm]	DDPC-...	DDPC-...-C	DDPC-...	DDPC-...-C	[Nm]		[g]		
80	175	270	143	238	28+2	1	1494	163529	DAMT-V1-80-A
100	117	215	120	218	28+2	1	2095	163530	DAMT-V1-100-A

1) Corrosion resistance class CRC 1 to Festo standard FN 940070

Low corrosion stress. For dry indoor applications or transport and storage protection. Also applies to parts behind covers, in the non-visible interior area, and parts which are covered in the application (e.g. drive trunnions).

Standard cylinders DDPG, integrated displacement encoder



Accessories

Trunnion support LNZZ

Materials:

Trunnion support: Anodised aluminium

Plain bearing: Plastic

Free of copper and PTFE

RoHS-compliant

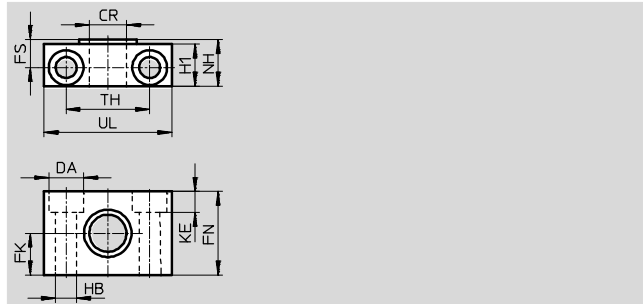
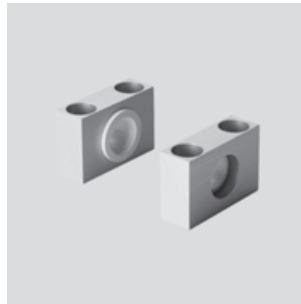

Dimensions and ordering data															Weight	Part No.	Type
For \varnothing	CR	DA	FK	FN	FS	H1	HB	KE	NH	TH	UL	CRC ¹⁾					
[mm]	\varnothing	\varnothing	\varnothing				\varnothing			± 0.2			[g]				
80	20	18	20	40	13	20	11	11	23	42	65	2	178	32961	LNZZ-63/80		
100	25	20	25	50	16	24.5	14	13	28.5	50	75	2	306	32962	LNZZ-100/125		

1) Corrosion resistance class CRC 2 to Festo standard FN 940070

Moderate corrosion stress. Indoor applications in which condensation may occur. External visible parts with primarily decorative requirements for the surface and which are in direct contact with the ambient atmosphere typical for industrial applications.

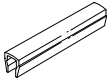
Ordering data				Part No.	Type	PU ¹⁾
Slot cover	For \varnothing	Comment				
	80, 100	Every 0.5 m		151680	ABP-5-S	2

Technical data → Internet: abp

1) Packaging unit

-  - Note

Recommended proximity sensor
→ Internet: dsbc

Standard cylinders DDPC, integrated displacement encoder

Accessories

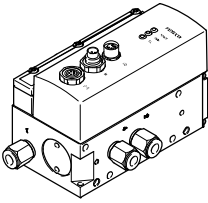
Ordering data – Proportional directional control valves and push-in fittings							
	For Ø [mm]	Stroke [mm]	Proportional directional control valve		Push-in fitting for DDPC		
			Technical data → Internet: vpwp		Technical data → Internet: qs		
			Part No.	Type	Part No.	Type	PU ¹⁾
	For applications with axis controller CPX-CMAX						
	80	100 ... 200	550171	VPWP-6-L-5-Q8-10-E-...	186100	QS-G3/8-8	10
		201 ... 450	550172	VPWP-8-L-5-Q10-10-E-...	186102	QS-G3/8-10	
		451 ... 750	1552544	VPWP-10-L-5-Q-10-E-G-EX1	186103	QS-G3/8-12	
	100	100 ... 120	550171	VPWP-6-L-5-Q8-10-E-...	186104	QS-G1/2-12²⁾	1
		121 ... 330	550172	VPWP-8-L-5-Q10-10-E-...	186104	QS-G1/2-12³⁾	
331 ... 750		1552544	VPWP-10-L-5-Q-10-E-G-EX1	186104	QS-G1/2-12		

- 1) Packaging unit
- 2) With additional reduction from Ø 12 to Ø 8, with push-in connector QS-12H-8 (part number 130624)
- 3) With additional reduction from Ø 12 to Ø 10, with push-in connector QS-12H-10 (part number 153044)

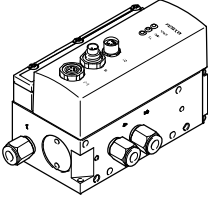
Ordering data – Proportional directional control valves and push-in fittings							
	For Ø [mm]	Stroke [mm]	Proportional directional control valve		Push-in fitting for DDPC		
			Technical data → Internet: vpwp		Technical data → Internet: qs		
			Part No.	Type	Part No.	Type	PU ¹⁾
	For applications with Soft Stop end-position controller CPX-CMPX						
	80	100 ... 125	550170	VPWP-4-L-5-Q8-10-E-...	186100	QS-G3/8-8	10
		126 ... 160	550171	VPWP-6-L-5-Q8-10-E-...	186100	QS-G3/8-8	
		161 ... 400	550172	VPWP-8-L-5-Q10-10-E-...	186102	QS-G3/8-10	
		401 ... 500	1552544	VPWP-10-L-5-Q-10-E-G-EX1	186103	QS-G3/8-12	
	100	100 ... 150	550171	VPWP-6-L-5-Q8-10-E-...	186104	QS-G1/2-12²⁾	1
		151 ... 350	550172	VPWP-8-L-5-Q10-10-E-...	186104	QS-G1/2-12³⁾	
351 ... 500		1552544	VPWP-10-L-5-Q-10-E-G-EX1	186104	QS-G1/2-12		

- 1) Packaging unit
- 2) With additional reduction from Ø 12 to Ø 8, with push-in connector QS-12H-8 (part number 130624)
- 3) With additional reduction from Ø 12 to Ø 10, with push-in connector QS-12H-10 (part number 153044)

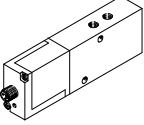
Ordering data – Proportional directional control valves and push-in fittings							
	For Ø [mm]	Stroke [mm]	Proportional directional control valve		Push-in fitting for DDPC		
			Technical data → Internet: mppe		Technical data → Internet: qs		
			Part No.	Type	Part No.	Type	PU ¹⁾
	For applications with Soft Stop end-position controller SPC11						
	80	100 ... 125	151692	MPYE-5-1/8-LF-010-B	186100	QS-G3/8-8	10
		126 ... 160	151693	MPYE-5-1/8-HF-010-B	186100	QS-G3/8-8	
		161 ... 400	151694	MPYE-5-1/4-010-B	186102	QS-G3/8-10	
		401 ... 500	151695	MPYE-5-3/8-010-B	186103	QS-G3/8-12	
	100	100 ... 150	151693	MPYE-5-1/8-HF-010-B	186104	QS-G1/2-12²⁾	1
		151 ... 350	151694	MPYE-5-1/4-010-B	186104	QS-G1/2-12³⁾	
351 ... 500		151695	MPYE-5-3/8-010-B	186104	QS-G1/2-12		

- 1) Packaging unit
- 2) With additional reduction from Ø 12 to Ø 8, with push-in connector QS-12H-8 (part number 130624)
- 3) With additional reduction from Ø 12 to Ø 10, with push-in connector QS-12H-10 (part number 153044)

Festo North America

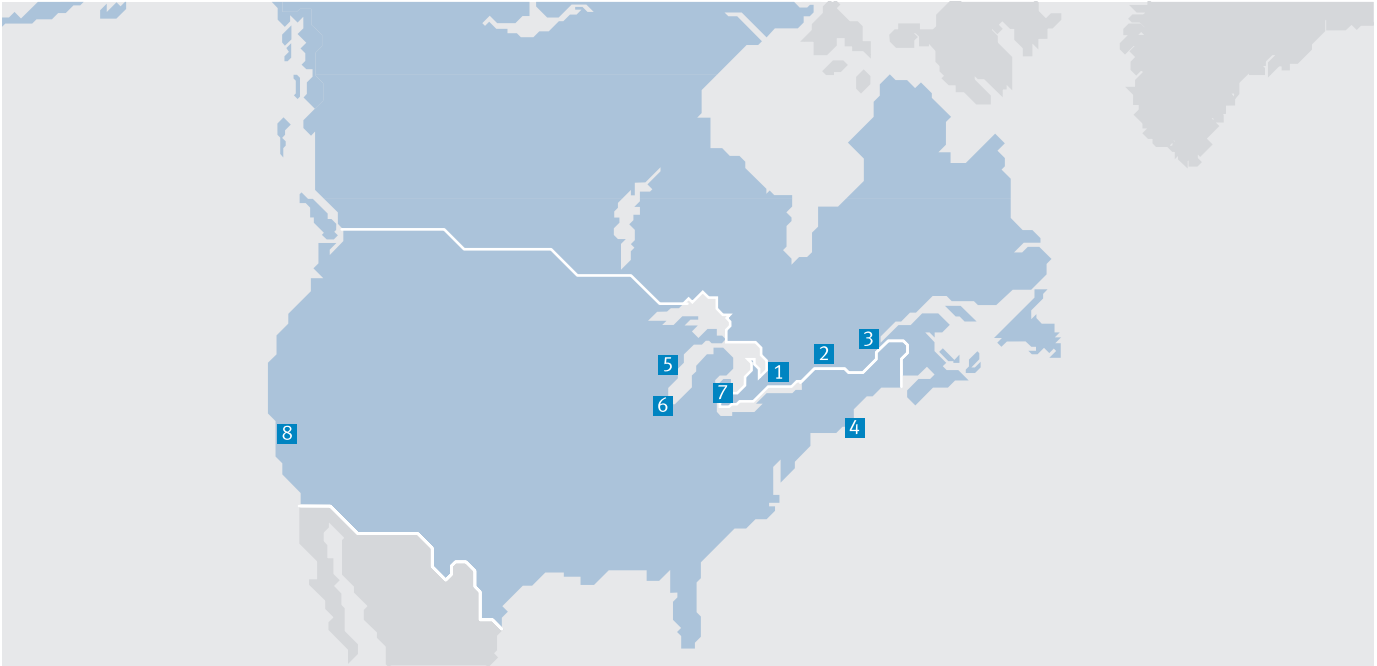

**1 Festo Canada
Headquarters
Festo Inc.**
5300 Explorer Drive
Mississauga, ON
L4W 5G4

2 Montréal
5600, Trans-Canada
Pointe-Claire, QC
H9R 1B6

3 Québec City
2930, rue Watt#117
Québec, QC
G1X 4G3



**4 Festo United States
Headquarters
Festo Corporation**
395 Moreland Road
Hauppauge, NY
11788

5 Appleton
North 922 Tower View Drive, Suite N
Greenville, WI
54942

7 Detroit
1441 West Long Lake Road
Troy, MI
48098

6 Chicago
85 W Algonquin - Suite 340
Arlington Heights, IL
60005

8 Silicon Valley
4935 Southfront Road, Suite F
Livermore, CA
94550

Festo Regional Contact Center

Canadian Customers

Commercial Support:
Tel: 1 877 GO FESTO (1 877 463 3786)
Fax: 1 877 FX FESTO (1 877 393 3786)
Email: festo.canada@ca.festo.com

Technical Support:
Tel: 1 866 GO FESTO (1 866 463 3786)
Fax: 1 877 FX FESTO (1 877 393 3786)
Email: technical.support@ca.festo.com

USA Customers

Commercial Support:
Tel: 1 800 99 FESTO (1 800 993 3786)
Fax: 1 800 96 FESTO (1 800 963 3786)
Email: customer.service@us.festo.com

Technical Support:
Tel: 1 866 GO FESTO (1 866 463 3786)
Fax: 1 800 96 FESTO (1 800 963 3786)
Email: product.support@us.festo.com

Subject to change

Internet: www.festo.com/us