

Parallel grippers HGPLE, sturdy with long stroke, electric

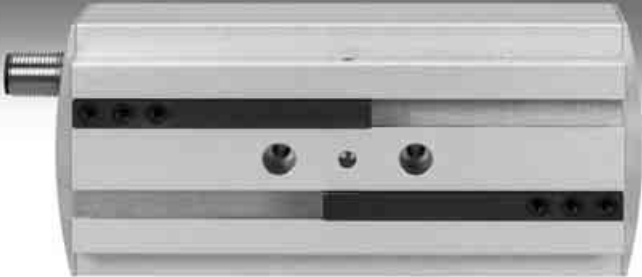

Parallel grippers HGPLE, sturdy with long stroke, electric

Key features



At a glance

With free, speed-controlled selection of the gripping positions, flexible access is no longer a problem with the parallel gripper HGPLE. Its long stroke

means it can be used with workpieces of different sizes. The option to adjust the gripping force makes the HGPLE

ideal for soft or very delicate workpieces. It also grips large and heavy workpieces reliably.

Economical

- A “pre-holding” position enables the HGPLE to stop its gripper fingers just short of the workpiece, thus reducing access times to an absolute minimum. Even when the size of the workpiece requires the entire

stroke, the HGPLE still offers impressively short opening and closing times of 0.6 s.

- The installation complexity is minimal as only one cable is required (from the controller to the gripper).

Sturdy

The T-slot gives the HGPLE very high torque resistance as well as very high precision.

Flexible

It is actuated on-site using the tried and tested motor controller SFC-DC.

Everything from a single source

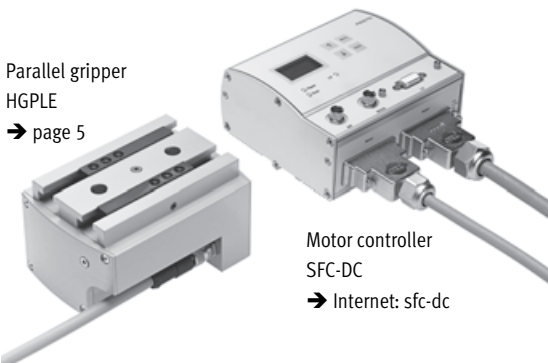

The parallel gripper and motor controller SFC form one unit.

- Thanks to IP54 degree of protection, the SFC can be mounted close to the HGPLE, either:
 - via central supports or
 - via H-rail
- The motor controller SFC is available with or without control panel
- Easy actuation via:
 - PROFIBUS
 - CANopen
 - DeviceNet

Parameterisation possible via:

- Control panel:
 - Suitable for easy positioning sequences
- FCT (Festo Configuration Tool) configuration package:
 - Parameterisation via RS 232 interface
 - Windows-based PC user interface, Festo Configuration Tool
 - Tool is included in scope of delivery



Note
These grippers are not suitable for the following or similar applications:

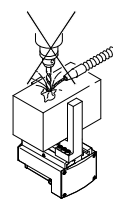

- Aggressive media
- Machining

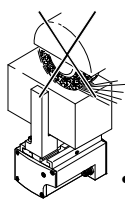

- Grinding dust

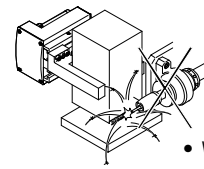

- Welding spatter

Parallel grippers HGPLE, sturdy with long stroke, electric

Key features and peripherals overview

Mounting options

Direct mounting

From above

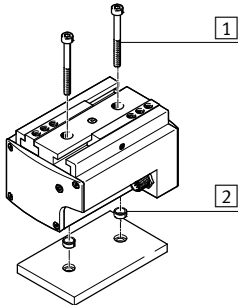

- 1 Mounting screws
- 2 Centring sleeves

From underneath

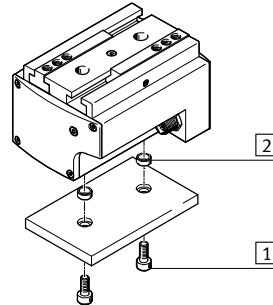

- 1 Mounting screws
- 2 Centring sleeves

Peripherals overview

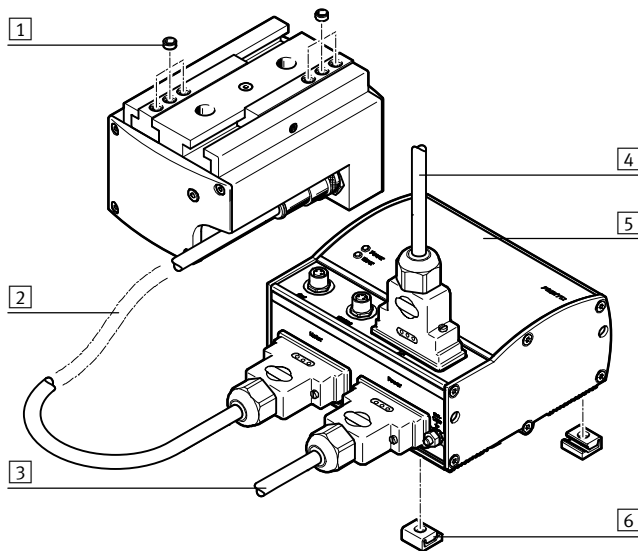

System product for handling and assembly technology

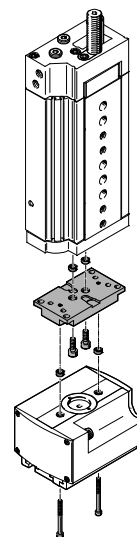

Accessories			
Type	Description	→ Page/Internet	
1 Centring sleeve ZBH	For centring attachments	11	
2 Motor cable KMTR	Connecting cable between motor and motor controller	sfc-dc	
3 Supply cable KPWR	Power supply cable; load and logic power supplies are separate	sfc-dc	
4 Plug connector FBS, FBA	For fieldbus interface	sfc-dc	
5 Motor controller SFC	For parameterising and positioning the parallel gripper	sfc-dc	
6 Central support MUP	– For mounting the motor controller – Motor controller can also be mounted on an H-rail	sfc-dc	
– Gripper jaw blank BUB-HGPL	Unmachined part specially matched to the gripper jaws for custom fabrication of gripper fingers	11	

Parallel grippers HGPLE, sturdy with long stroke, electric

Type codes

HGPLE – 25 – 40 – 2,8 – DC – VCSC – G85

Type

HGPLE	Parallel gripper
-------	------------------

Size

Stroke [mm] per gripper jaw

Spindle pitch

2,8	2.8 mm
3,1	3.1 mm

Motor type

DC	DC motor
----	----------

Nominal voltage/plug connector type

VCSC	24 V
------	------

Gear reduction



G85	85:1
G96	96:1

Parallel grippers HGPLE, sturdy with long stroke, electric

Technical data

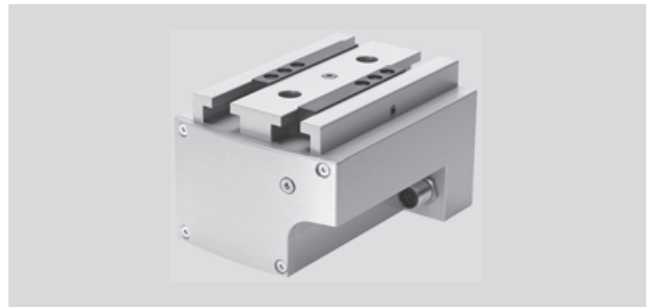
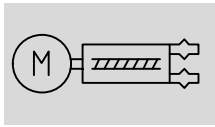
Function



-  Size
14 and 25 mm
-  Stroke
30 ... 80 mm

General technical data				
Size	14		25	
Stroke	30	60	40	80
Design	Worm gear unit with integrated displacement encoder Rack and pinion			
Guidance	Plain-bearing guide with T-slot			
Mode of operation	Double-acting			
Gripper function	Parallel			
Number of gripper jaws	2			
Stroke per gripper jaw, adjustable [mm]	0 ... 30	0 ... 60	0 ... 40	0 ... 80
Max. load per gripper finger ¹⁾ [g]	150	150	500	500
Repetition accuracy ²⁾ [mm]	≤ 0.05			
Max. interchangeability [mm]	≤ 0.2			
Reversing backlash ³⁾ [mm]	≤ 0.35			
Rotational symmetry [mm]	≤ 0.2			
Max. gripper jaw backlash [mm]	≤ 0.05			
Max. gripper jaw angular backlash [°]	≤ 0.2			
Homing	Negative fixed stop block Positive fixed stop block			
Position sensing	Via integrated angular displacement encoder			
Type of mounting	Via through-holes and centring sleeves Via female thread and centring sleeves			
Electrical connection	12-pin M12x1 Plug connector			
Mounting position	Any			
Product weight [g]	520	700	1680	2030

- 1) Applies to unthrottled operation
- 2) End-position drift under constant operating conditions with 100 consecutive strokes in the direction of movement of the gripper jaws
- 3) In new condition

Electrical data for motor	
Motor type	DC servo motor
Nominal operating voltage [V DC]	24

Operating and environmental conditions	
Ambient temperature [°C]	5 ... 40
Degree of protection	IP40
Noise level [db (A)]	≤ 60
CE mark (see declaration of conformity) ¹⁾	To EU EMC Directive
Corrosion resistance class CRC ²⁾	2

- 1) For information about the applicability of the component see the manufacturer's EC declaration of conformity at: www.festo.com/sp → User documentation.
If the component is subject to restrictions on usage in residential, office or commercial environments or small businesses, further measures to reduce the emitted interference may be necessary.
- 2) Corrosion resistance class CRC 2 to Festo standard FN 940070
Moderate corrosion stress. Indoor applications in which condensation may occur. External visible parts with primarily decorative requirements for the surface and which are in direct contact with the ambient atmosphere typical for industrial applications.

Parallel grippers HGPLE, sturdy with long stroke, electric

Technical data

Materials

Sectional view

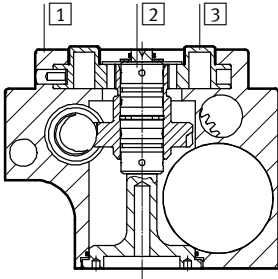

Parallel gripper

1	Housing	Wrought aluminium alloy, hard-anodised
2	Bearing	Rolled steel
3	Gripper jaw	Hardened steel
-	Note on materials	Free of copper and PTFE RoHS-compliant

Gripping force F_h per gripper jaw as a function of travel speed v and lever arm x

The gripping forces as a function of travel speed and lever arm can be determined using following graphs.

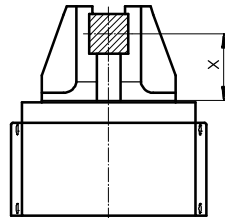

HGPLE-14

Opening

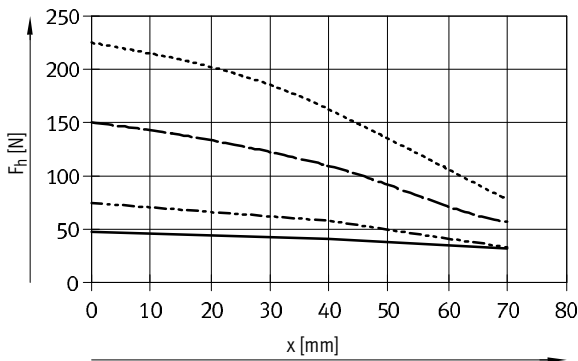

Closing

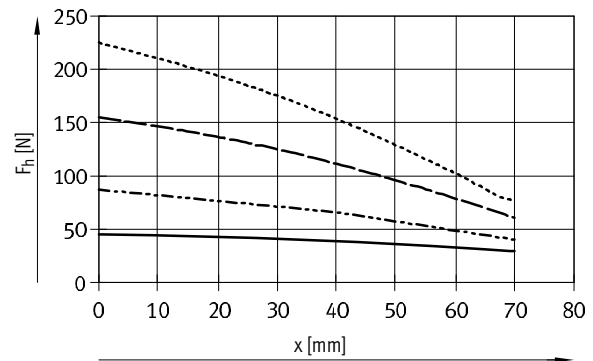

HGPLE-25

Opening

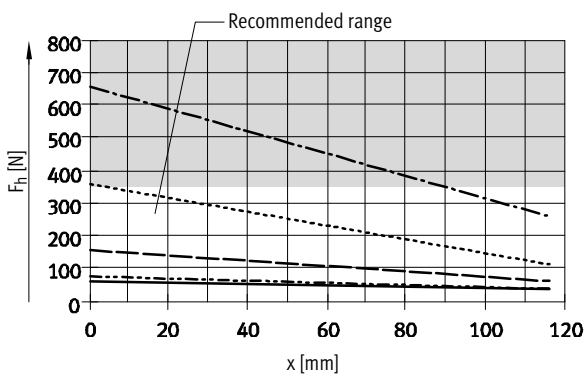

Closing

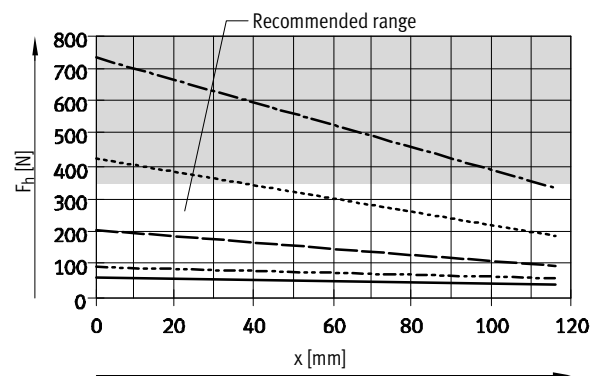

Parallel grippers HGPLE, sturdy with long stroke, electric

Technical data

Total gripping force F with a lever arm X = 20 mm								
Travel speed v	[mm/s]	2	5	10	20	30	40	60
HGPLE-14								
Opening	[N]	92	93	149	300	450	–	–
Closing	[N]	88	104	173	305	445	–	–
HGPLE-25								
Opening	[N]	120	120	148	293	–	652	1150
Closing	[N]	121	120	176	376	–	771	1300

Characteristic load values at the gripper jaws

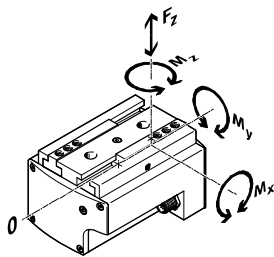

The indicated permissible forces and torques apply to a single gripper jaw. They include the lever arm, additional applied loads due to the workpiece or external gripper fingers and acceleration forces occurring during movement.

The zero co-ordinate line (gripper jaw guide groove) must be taken into consideration for the calculation of torques.

Size	14	25			
Stroke	30	60	40	80	
Max. permissible force F_z	[N]	500	500	1500	1500
Max. permissible torque M_x	[Nm]	25	35	100	140
Max. permissible torque M_y	[Nm]	25	35	60	90
Max. permissible torque M_z	[Nm]	25	35	70	100

Mass moment of inertia [kgcm²]

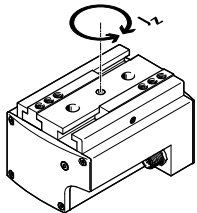

- Under the following conditions:
- The reference point is the central axis
 - Without external gripper fingers
 - In a load-free state

Size	14	25			
Stroke	30	60	40	80	
Mass moment of inertia J_z	[kgcm ²]	4.24	11.64	28.32	72.72

Positioning time t as a function of stroke per gripper jaw l and travel speed v

HGPLE-14

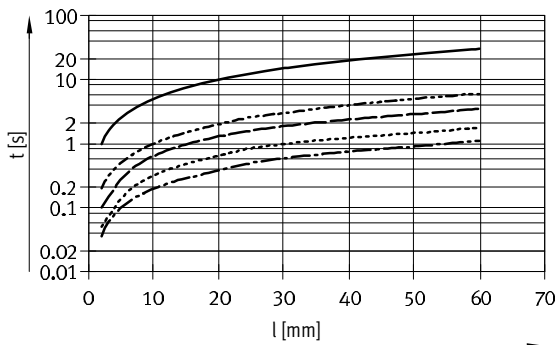

- v = 2 mm/s
- - - v = 10 mm/s
- · - v = 20 mm/s
- - - v = 40 mm/s
- - - v = 55 mm/s

HGPLE-25

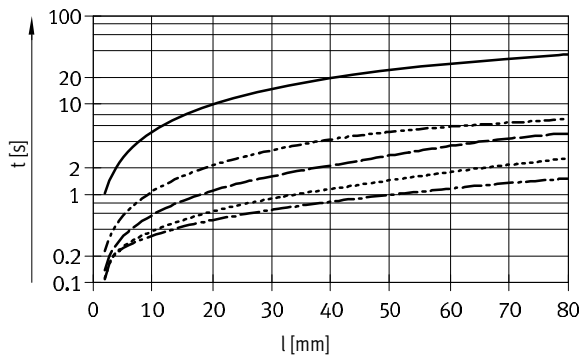

- v = 2 mm/s
- - - v = 10 mm/s
- · - v = 20 mm/s
- - - v = 40 mm/s
- - - v = 65 mm/s

Parallel grippers HGPLE, sturdy with long stroke, electric

Technical data

Gripping force F_h per gripper jaw as a function of lever arm x and eccentricity a and b

The following formula must be used to calculate the lever arm x with eccentric gripping:

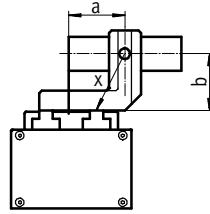

$$x = \sqrt{a^2 + b^2}$$

The gripping force F_h can then be read from the graphs (→ page 6) using the calculated value x .

Calculation example

Given:

Distance $a = 60$ mm

Distance $b = 70$ mm

To be found:

The gripping force at 40 mm/s

with a HGPLE-25-40,

used as an external gripper

Approach:

Calculating the lever arm x

$$x = \sqrt{60^2 + 70^2}$$

$$x = 92 \text{ mm}$$

The graph (→ page 6) gives a value for the gripping force F_h of approx.

245 N.

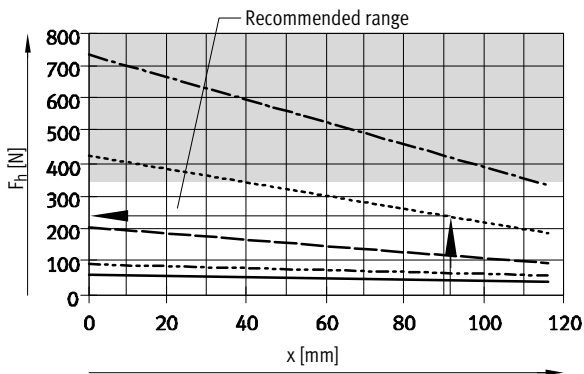

Pin allocation of plug connector

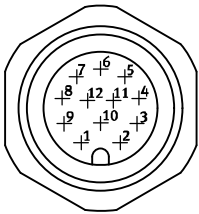

M12 plug connector

Pin	Port	Function
1	Motor +	Motor conductor
2	Motor -	Motor conductor
3	A	Encoder signal RS 485
4	A/	Encoder signal RS 485
5	B	Encoder signal RS 485
6	B/	Encoder signal RS 485
7	I	Encoder signal RS 485
8	I/	Encoder signal RS 485
9	+5 V DC	Signal supply
10	0V	Signal ground
11	-	Preassigned
12	-	Preassigned

Parallel grippers HGPLE, sturdy with long stroke, electric

Technical data

Dimensions

Download CAD data → www.festo.com

HGPLE-14

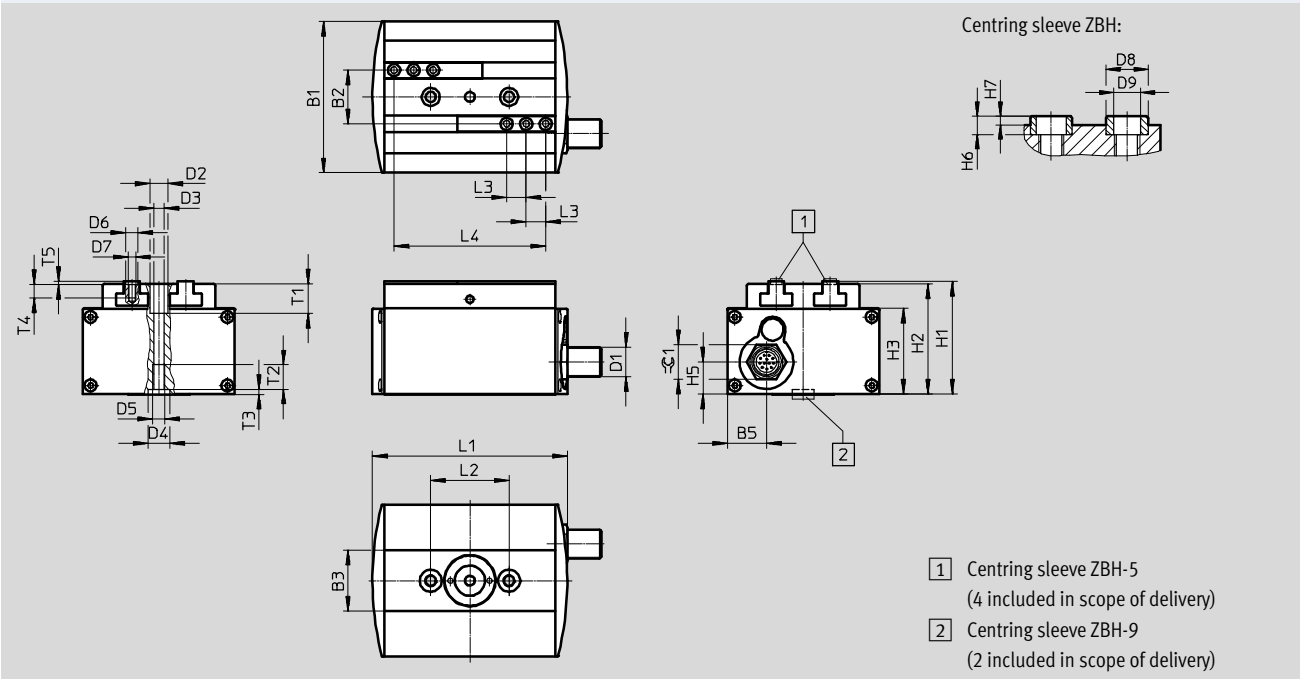

Type	B1	B2	B3	B5	D1	D2 ∅	D3 ∅	D4 ∅	D5	D6 ∅	D7
	±0.05	±0.01	±1			H13		H8		H8	
HGPLE-14-30	62	22	25	16	M12x1	7.4	4.2	9	M5	5	M3
HGPLE-14-60											

Type	D8 ⁴⁾ ∅	D9 ⁴⁾ ∅	H1	H2	H3	H5	H6 ⁴⁾	H7 ⁴⁾	L1	L2 ¹⁾	L3 ¹⁾
	h7		±0.1				-0.2	-0.3	±0.3		
HGPLE-14-30	5/7	3.2/6.4	46.2	45.2	35.2	13.1	2.4/4	1.1/1.9	79.6	32	8
HGPLE-14-60									139.6		

Type	L4		T1	T2	T3	T4	T5	∅C
	max. ²⁾	min. ³⁾	+0.2	min.	+0.1	min.	+0.1	
HGPLE-14-30	62	2	12	10	2.1	5.5	1.3	14
HGPLE-14-60	122	2						

- 1) Tolerance for centring hole ±0.02 mm
Tolerance for thread ±0.1 mm
- 2) Gripper open
- 3) Gripper closed
- 4) On the gripper jaw/on the gripper

Parallel grippers HGPLE, sturdy with long stroke, electric

Technical data

FESTO

Dimensions

Download CAD data → www.festo.com

HGPLE-25

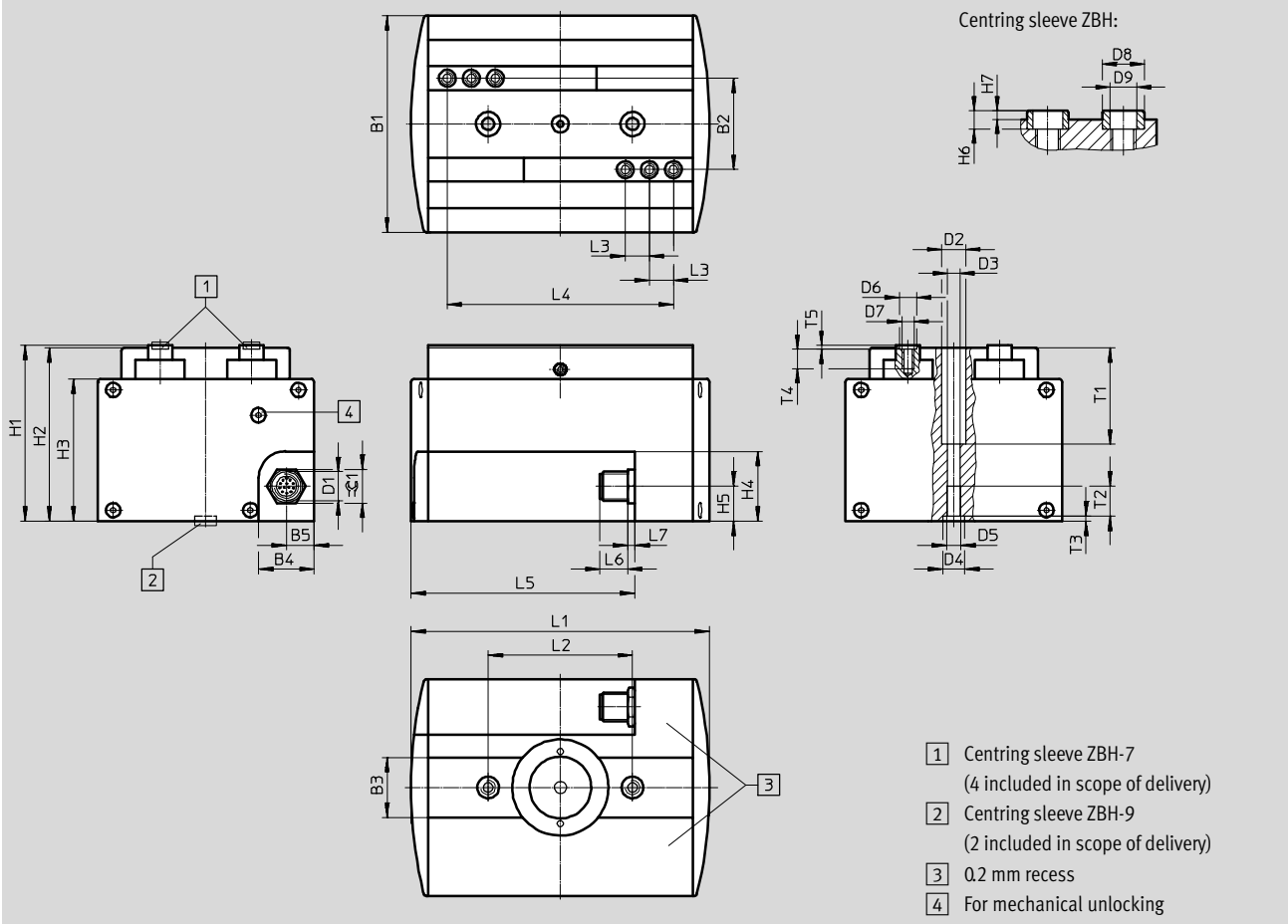

Type	B1	B2	B3	B4	B5	D1	D2	D3	D4	D5	D6	D7
	±0.05	±0.01	±1				∅ H13	∅ +0.1	∅ H8		∅ H8	
HGPLE-25-40	90	38	25	23	11.5	M12x1	10	5.1	9	M6	7	M5
HGPLE-25-80												

Type	D8 ⁴⁾	D9 ⁴⁾	H1	H2	H3	H4	H5	H6 ⁴⁾	H7 ⁴⁾	L1	L2 ¹⁾	L3 ¹⁾
	∅ h7	∅	±0.1					-0.2	-0.3	±0.3		
HGPLE-25-40	7/9	5.3/6.4	73	72	59	29	14.5	3/4	1.4/1.9	124	60	10
HGPLE-25-80										204		

Type	L4		L5	L6	L7	T1	T2	T3	T4	T5	⊕
	max. ²⁾	min. ³⁾									
HGPLE-25-40	94	14	93	11.5	3	40	12.5	2.1	8	1.6	14
HGPLE-25-80	174	14	133								

- 1) Tolerance for centring hole ±0.02 mm
Tolerance for thread ±0.1 mm
- 2) Gripper open
- 3) Gripper closed
- 4) On the gripper jaw/on the gripper

Parallel grippers HGPLE, sturdy with long stroke, electric

Technical data

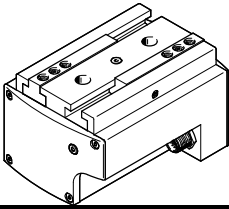
Ordering data	
Part No.	Type
	2342434 HGPLE-14-30-3,1-DC-VCSC-G96
	2342435 HGPLE-14-60-3,1-DC-VCSC-G96
	555563 HGPLE-25-40-2,8-DC-VCSC-G85
	2342436 HGPLE-25-80-2,8-DC-VCSC-G85

Accessories

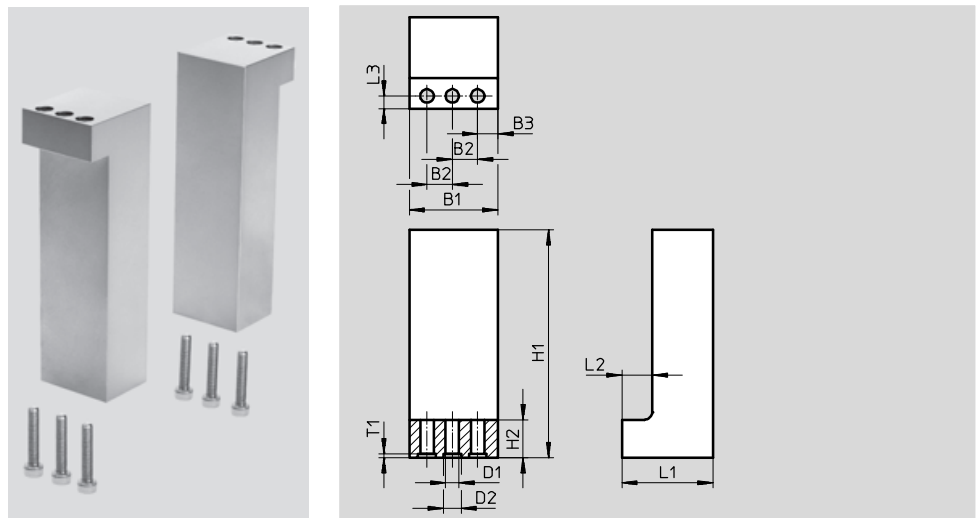

Gripper jaw blank BUB-HGPL
(2 included in delivery)

Materials:
Wrought aluminium alloy
Free of copper and PTFE
RoHS-compliant



Dimensions and ordering data							
For size	B1	B2	B3	D1	D2	H1	H2
	+0.1	+0.02		∅ +0.1	∅ H8	+0.1	
14	25	8	4	3.2	5	80	11
25	35	10	8	5.3	7	120	15

For size	L1	L2	L3	T1	Weight per blank [g]	Part No.	Type
	+0.1	+0.1	+0.1	+0.1			
14	20.5	8	3.3	1.3	75	537316	BUB-HGPL-14
25	36	12	5	1.6	295	537317	BUB-HGPL-25

Ordering data – Centring sleeve				
	For size	Part No.	Type	PU ¹⁾
For the gripper jaws Technical data → Internet: zbh				
	14	189652	ZBH-5	10
	25	186717	ZBH-7	
For the gripper Technical data → Internet: zbh				
	14, 25	150927	ZBH-9	10

1) Packaging unit

Parallel grippers HGPLE, sturdy with long stroke, electric





Accessories

Adapter kit
DHAA, HAPG

Materials:
Wrought aluminium alloy
Free of copper and PTFE
RoHS-compliant

 Note
The kit includes the individual mounting interface as well as the necessary mounting material.

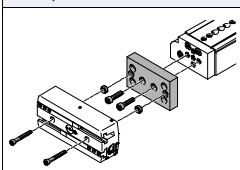
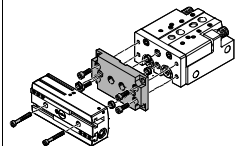
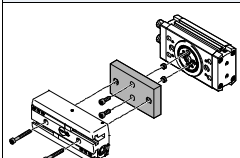
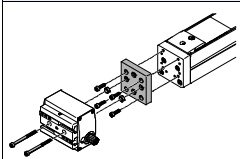
Permissible drive/gripper combinations with adapter kit						Download CAD data → www.festo.com	
Combination	Drive	Gripper			Adapter kit		
	Size	Size	Mounting option		CRC ¹⁾	Part No.	Type
							
DGSL/HGPLE 	DGSL	HGPLE			DHAA/HAPG		
	16	14	■	■	2	2519367	DHAA-G-G6-16-B17-14
	20, 25	14	■	■		2515219	DHAA-G-G6-20-B17-14
	25	25	■	■		539274	HAPG-90
SLT/HGPLE 	SLT	HGPLE			DHAA		
	16	14	■	–	2	2531838	DHAA-G-G3-16-B17-14
	20	14	■	–		2516304	DHAA-G-G3-20-B17-14
	25	14	■	–		2516252	DHAA-G-G3-25-B17-14
	25	25	■	–		8033603	DHAA-G-G3-25-B17-25
DRRD/HGPLE 	DRRD	HGPLE			DHAA		
	16	14	■	■	2	8034057	DHAA-G-Q11-16-B17-14
	20	14	■	■		8034058	DHAA-G-Q11-20-B17-14
	25	14	■	■		3122168	DHAA-G-Q11-25-B17-14
	25	25	■	■		8033607	DHAA-G-Q11-25-B17-25
	32	25	■	■		8033608	DHAA-G-Q11-32-B17-25
	35	25	■	■		8033609	DHAA-G-Q11-35-B17-25
DGEA/HGPLE 	DGEA	HGPLE			DHAA		
	25	14	■	■	2	2786045	DHAA-G-E2-25-B17-14
	40	14	■	■		2806354	DHAA-G-E2-40-B17-14

1) Corrosion resistance class CRC 2 to Festo standard FN 940070
Moderate corrosion stress. Indoor applications in which condensation may occur. External visible parts with primarily decorative requirements for the surface and which are in direct contact with the ambient atmosphere typical for industrial applications.



Parallel grippers HGPLE, sturdy with long stroke, electric

Accessories

Adapter kit
DHAA, HAPG

Material:
Wrought aluminium alloy
Free of copper and PTFE
RoHS-compliant

 Note
The kit includes the individual mounting interface as well as the necessary mounting material.

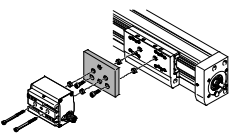
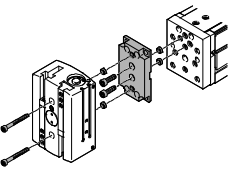
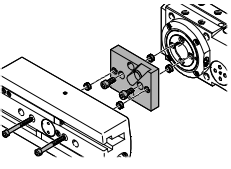
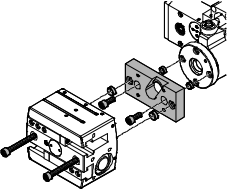
Permissible drive/gripper combinations with adapter kit					Download CAD data → www.festo.com	
Combination	Drive	Gripper	Mounting option		Adapter kit	
			Size	Size	CRC ¹⁾	Part No. Type
						
	EGC	HGPLE			DHAA	
	70	14	■	■	2	2808960 DHAA-G-E7-70-B17-14
	80	14	■	■		2810619 DHAA-G-E7-80-B17-14
	120	25	■	■		8033604 DHAA-G-E7-120-B17-25
	185	25	■	■		8033605 DHAA-G-E7-185-B17-25
	EGSL	HGPLE			DHAA	
	45, 55	14	■	■	2	2519367 DHAA-G-G6-16-B17-14
	75	14	■	■		2515219 DHAA-G-G6-20-B17-14
	ERMB	HGPLE			DHAA	
	20	14	■	■	2	2807590 DHAA-G-R1-20-B17-14
	25	14	■	■		2812698 DHAA-G-R1-25-B17-14
	32	25	■	■		8033606 DHAA-G-R1-32-B17-25
	EHMB	HGPLE			HAPG	
	20	25	■	■	2	537311 HAPG-SD2-29

1) Corrosion resistance class CRC 2 to Festo standard FN 940070
Moderate corrosion stress. Indoor applications in which condensation may occur. External visible parts with primarily decorative requirements for the surface and which are in direct contact with the ambient atmosphere typical for industrial applications.

Festo North America

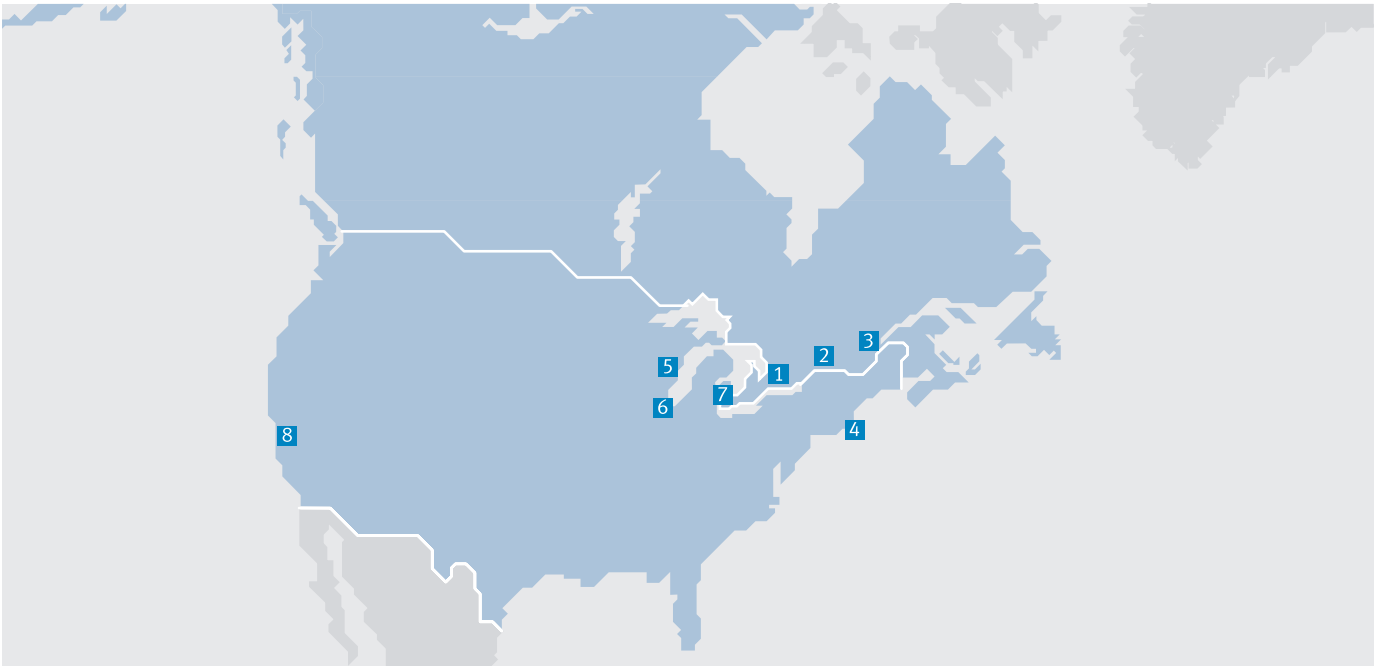

**1 Festo Canada
Headquarters
Festo Inc.**
5300 Explorer Drive
Mississauga, ON
L4W 5G4

2 Montréal
5600, Trans-Canada
Pointe-Claire, QC
H9R 1B6

3 Québec City
2930, rue Watt#117
Québec, QC
G1X 4G3



**4 Festo United States
Headquarters
Festo Corporation**
395 Moreland Road
Hauppauge, NY
11788

5 Appleton
North 922 Tower View Drive, Suite N
Greenville, WI
54942

7 Detroit
1441 West Long Lake Road
Troy, MI
48098

6 Chicago
85 W Algonquin - Suite 340
Arlington Heights, IL
60005

8 Silicon Valley
4935 Southfront Road, Suite F
Livermore, CA
94550

Festo Regional Contact Center

Canadian Customers

Commercial Support:
Tel: 1 877 GO FESTO (1 877 463 3786)
Fax: 1 877 FX FESTO (1 877 393 3786)
Email: festo.canada@ca.festo.com

Technical Support:
Tel: 1 866 GO FESTO (1 866 463 3786)
Fax: 1 877 FX FESTO (1 877 393 3786)
Email: technical.support@ca.festo.com

USA Customers

Commercial Support:
Tel: 1 800 99 FESTO (1 800 993 3786)
Fax: 1 800 96 FESTO (1 800 963 3786)
Email: customer.service@us.festo.com

Technical Support:
Tel: 1 866 GO FESTO (1 866 463 3786)
Fax: 1 800 96 FESTO (1 800 963 3786)
Email: product.support@us.festo.com

Subject to change

Internet: www.festo.com/us