

Position transmitters SMAT-8M, for T-slot

FESTO



Position transmitters SMAT-8M, for T-slot

Key features

Design

General

The SMAT-8M is a position transmitter for the contactless sensing of the piston position of drives that can be detected magnetically. It supplies a displacement-proportional analogue

output signal in the position measuring range. It is connected directly to the analogue PLC inputs without any accessories. With its extremely compact design,

the SMAT-8M is the ideal solution for grippers, short-stroke cylinders and all applications in which installation space is restricted.

Note
It can be used with Festo cylinders with T-slot (profile slot 8) as well as round cylinders and tie-rod cylinders with mounting kits. A selection aid with suitable drives can be found on the following pages.

Position measuring range

The SMAT-8M supplies a displacement-proportional analogue output signal of 0 ... 10 V in the position measuring range of up to 40 mm (depending on the drive used). In other words, the output voltage increases when the piston moves in the direction of the piston rod. When the piston retracts, the output voltage drops. The installation direction of the SMAT-8M is irrelevant in this case. To achieve the best possible function on the drive in question, the position measuring range must be initialised on the drive during installation.

As a visual aid, the green LED lights up within the position measuring range (B) and the red LED lights up outside of the measuring range (A)/(C) in normal operation.

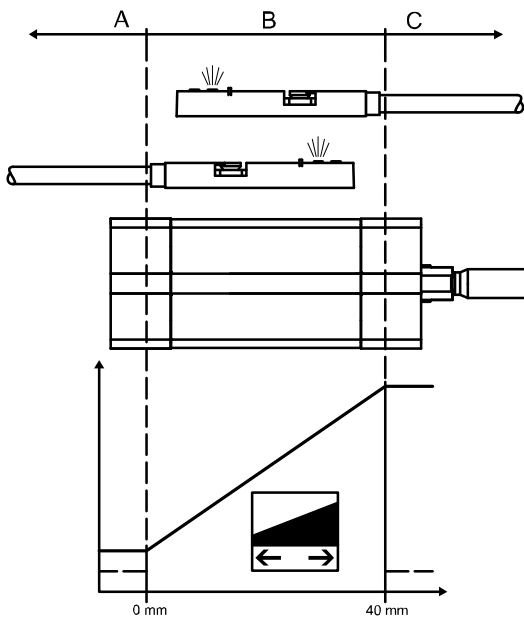

Repetition accuracy

The repetition accuracy is ± 0.025 mm on grippers and ± 0.1 mm on standard drives.

With standard drives, the repetition accuracy in the centre of the measuring range is lower than at the edge. It is ± 0.06 mm at a distance of ± 5 mm from the centre, for example. For critical applications, it is recommended that the SMAT-8M be mounted so as to have the relevant measuring points close to 5.5 V.

Repetition accuracy as a function of position measuring range S

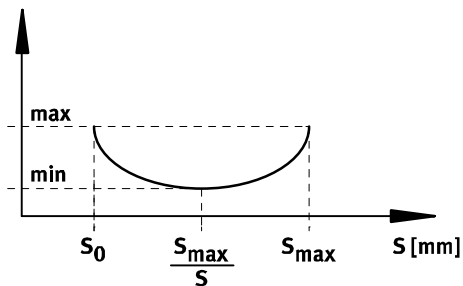

Position transmitters SMAT-8M, for T-slot

Selection aid

FESTO

Drive/gripper	Usability on drive	Position measuring range approx.	
		With initialisation [mm]	Without initialisation ²⁾ [mm]
Standards-based cylinders			
Standard cylinder DSBC-32	+	26	26
Standard cylinder DSBC-40	+	26	26
Standard cylinder DSBC-50	+	30	27
Standard cylinder DSBC-63	+	33	33
Standard cylinder DSBC-80	+	37	37
Standard cylinder DSBC-100	+	33	31
Standard cylinder DSBC-125	+	35	34
Standard cylinder DSBG-32	+	19	17
Standard cylinder DSBG-40	+	24	23
Standard cylinder DSBG-50	+	27	26
Standard cylinder DSBG-63	+	27	27
Standard cylinder DSBG-80	+	30	33
Standard cylinder DSBG-100	+	29	27
Standard cylinder DSBG-125	+	27	24
Standard cylinder DSBG-160	+	33	23
Standard cylinder DSBG-200	+	29	24
Standard cylinder DSBG-250	+	19	19
Standard cylinder DSBG-320	+	18	17
Standard cylinder DSNU/ESNU-8	+	19	17
Standard cylinder DSNU/ESNU-10	+	22	19
Standard cylinder DSNU/ESNU-12	+	21	19
Standard cylinder DSNU/ESNU-16	+	21	19
Standard cylinder DSNU/ESNU-20	+	20	18
Standard cylinder DSNU/ESNU-25	+	28	22
Round cylinder DSNU/ESNU-32	+	25	23
Round cylinder DSNU/ESNU-40	+	29	30
Round cylinder DSNU/ESNU-50	+	31	29
Round cylinder DSNU/ESNU-63	+	36	33
Standard cylinder DNCB-32	+	25	23
Standard cylinder DNCB-40	+	28	19
Standard cylinder DNCB-50	+	30	26
Standard cylinder DNCB-63	+	32	27
Standard cylinder DNCB-80	+	35	32
Standard cylinder DNCB-100	+	29	26
Standard cylinder DNC-32	+	29	32
Standard cylinder DNC-40	o ¹⁾	–	–
Standard cylinder DNC-50	o ¹⁾	–	–
Standard cylinder DNC-63	+	34	28
Standard cylinder DNC-80	+	35	29
Standard cylinder DNC-100	+	37	33
Standard cylinder DNC-125	+	38	32
Standard cylinder DNG-32	+	28	19
Standard cylinder DNG-40	+	34	30
Standard cylinder DNG-50	o ¹⁾	–	–
Standard cylinder DNG-63	+	32	25
Standard cylinder DNG-80	+	32	25
Standard cylinder DNG-100	+	32	27

Drive/gripper	Usability on drive	Position measuring range approx.	
		With initialisation [mm]	Without initialisation ²⁾ [mm]
Standards-based cylinders			
Compact cylinder AND/AEN-12	+	22	22
Compact cylinder ADN/AEN-16	+	26	26
Compact cylinder ADN/AEN-20	+	30	28
Compact cylinder ADN/AEN-25	+	27	24
Compact cylinder ADN/AEN-32	+	31	31
Compact cylinder ADN/AEN-40	+	28	20
Compact cylinder ADN/AEN-50	+	25	21
Compact cylinder ADN/AEN-63	+	31	29
Compact cylinder ADN/AEN-80	o ¹⁾	–	–
Compact cylinder ADN/AEN-100	+	28	24
Compact cylinder ADN/AEN-125	+	37	33
Cylinders with piston rod			
Short-stroke cylinder ADVC/AEVC-32	+	Stroke < position measuring range SMAT-8M	Stroke < position measuring range SMAT-8M
Short-stroke cylinder ADVC/AEVC-40	+	Stroke < position measuring range SMAT-8M	24
Short-stroke cylinder ADVC/AEVC-50	+		Stroke < position measuring range SMAT-8M
Short-stroke cylinder ADVC/AEVC-63	+		24
Short-stroke cylinder ADVC/AEVC-80	+		24
Short-stroke cylinder ADVC/AEVC-100	+	23	20
Compact cylinder ADVU/AEVU-12	+	20	17
Compact cylinder ADVU/AEVU-16	+	29	28
Compact cylinder ADVU/AEVU-20	+	25	21
Compact cylinder ADVU/AEVU-25	+	27	23
Compact cylinder ADVU/AEVU-32	+	24	21
Compact cylinder ADVU/AEVU-40	+	22	18
Compact cylinder ADVU/AEVU-50	+	32	27
Compact cylinder ADVU/AEVU-63	+	35	28
Compact cylinder ADVU/AEVU-80	+	33	26
Compact cylinder ADVU/AEVU-100	+	35	31
Compact cylinder ADVU/AEVU-125	+	29	26
Flat cylinder DZF-12	+	26	24
Flat cylinder DZF-18	+	28	23
Flat cylinder DZF-25	+	26	17
Flat cylinder DZF-32	+	–	–
Flat cylinder DZF-40	o ¹⁾	–	–
Flat cylinder DZF-50	o ¹⁾	–	–
Flat cylinder DZF-63	o ¹⁾	–	–

+ Unrestricted use

o On request

1) Different from technical data. Usability on request.

2) Position measuring range without initialisation (as supplied from the factory)

Position transmitters SMAT-8M, for T-slot

Selection aid



Drive/gripper	Usability on drive	Position measuring range approx.	
		With initialisation [mm]	Without initialisation ²⁾ [mm]
Rodless cylinders			
Linear drive DGC-18	+	30	26
Linear drive DGC-25	o ¹⁾	–	–
Linear drive DGC-32	o ¹⁾	–	–
Linear drive DGC-40	o ¹⁾	–	–
Function-oriented drives			
Linear/swivel clamp CLR-12	+	22	22
Linear/swivel clamp CLR-16	+	26	26
Linear/swivel clamp CLR-20	+	30	28
Linear/swivel clamp CLR-25	+	27	24
Linear/swivel clamp CLR-32	+	31	31
Linear/swivel clamp CLR-40	+	28	20
Linear/swivel clamp CLR-50	+	25	21
Linear/swivel clamp CLR-63	+	31	29
Drives with linear guides			
Guided drive DFM-12	+	21	22
Guided drive DFM-16	+	15	16
Guided drive DFM-20	+	24	22
Guided drive DFM-25	+	26	25
Guided drive DFM-32	+	25	22
Guided drive DFM-40	o ¹⁾	–	–
Guided drive DFM-50	+	21	18
Guided drive DFM-63	+	31	27
Guided drive DFM-80	+	30	30
Guided drive DFM-100	+	25	24
Guided drive DFM-12-B	+	16	22
Guided drive DFM-16-B	+	20	21
Guided drive DFM-20-B	+	26	27
Guided drive DFM-25-B	+	24	22
Guided drive DFM-32-B	+	29	28
Guided drive DFM-40-B	+	30	29
Guided drive DFM-50-B	+	31	31
Guided drive DFM-63-B	+	33	32
Linear unit SLE-10	+	22	22
Linear unit SLE-16	+	21	21
Linear unit SLE-20	+	20	20
Linear unit SLE-25	+	28	28
Linear unit SLE-32	+	25	25
Linear unit SLE-40	+	29	29
Linear unit SLE-50	+	31	31

Drive/gripper	Usability on drive	Position measuring range approx.	
		With initialisation [mm]	Without initialisation ²⁾ [mm]
Handling units			
Three-point gripper DHDS-32 (HGD)	+	Stroke < position measuring range SMAT-8M	
Three-point gripper DHDS-50 (HGD)	+		
Parallel gripper DHPS-10 (HGP)	+		
Parallel gripper DHPS-16 (HGP)	+		
Parallel gripper DHPS-20 (HGP)	+		
Parallel gripper DHPS-25 (HGP)	+		
Parallel gripper DHPS-35 (HGP)	+		
Parallel gripper HGPL-63	+		
Parallel gripper HGPL-14- ... -B	+	9	8
Parallel gripper HGPL-25- ... -B	+	18	14
Parallel gripper HGPL-40- ... -B	+	19	15
Parallel gripper HGPL-63- ... -B	+	Stroke < position measuring range SMAT-8M	
Parallel gripper HGPT-40-B	+		
Parallel gripper HGPT-50-B	+		
Parallel gripper HGPT-63-B	+	16	15
Parallel gripper HGPT-80-B	+	16	12
Angle gripper DHWS-16 (HGW)	+	Stroke < position measuring range SMAT-8M	
Angle gripper DHWS-25 (HGW)	+		
Angle gripper DHWS-32 (HGW)	+		
Angle gripper DHWS-40 (HGW)	+		
Radial gripper DHRS-16 (HGR)	+		
Radial gripper DHRS-25 (HGR)	+		
Radial gripper DHRS-32 (HGR)	+		
Radial gripper DHRS-40 (HGR)	+		
Radial gripper HGRT-40-A-G2	+		
Radial gripper HGRT-50-A-G2	o ¹⁾		
Semi-rotary drives with rack and pinion			
Semi-rotary drive DRRD-16	+ ³⁾	17	19
Semi-rotary drive DRRD-20	+ ³⁾	13	13
Semi-rotary drive DRRD-25	+ ³⁾	28	28
Semi-rotary drive DRRD-32	+ ³⁾	29	29
Semi-rotary drive DRRD-35	+ ³⁾	34	33
Semi-rotary drive DRRD-40	+ ³⁾	32	32
Semi-rotary drive DRRD-50	+ ³⁾	32	32
Semi-rotary drive DRRD-63	o ¹⁾	–	–

+ Unrestricted use

o On request

1) Different from technical data. Usability on request.

2) Position measuring range without initialisation (as supplied from the factory)

3) Repetition accuracy ±0.5°

Position transmitters SMAT-8M, for T-slot

Peripherals overview

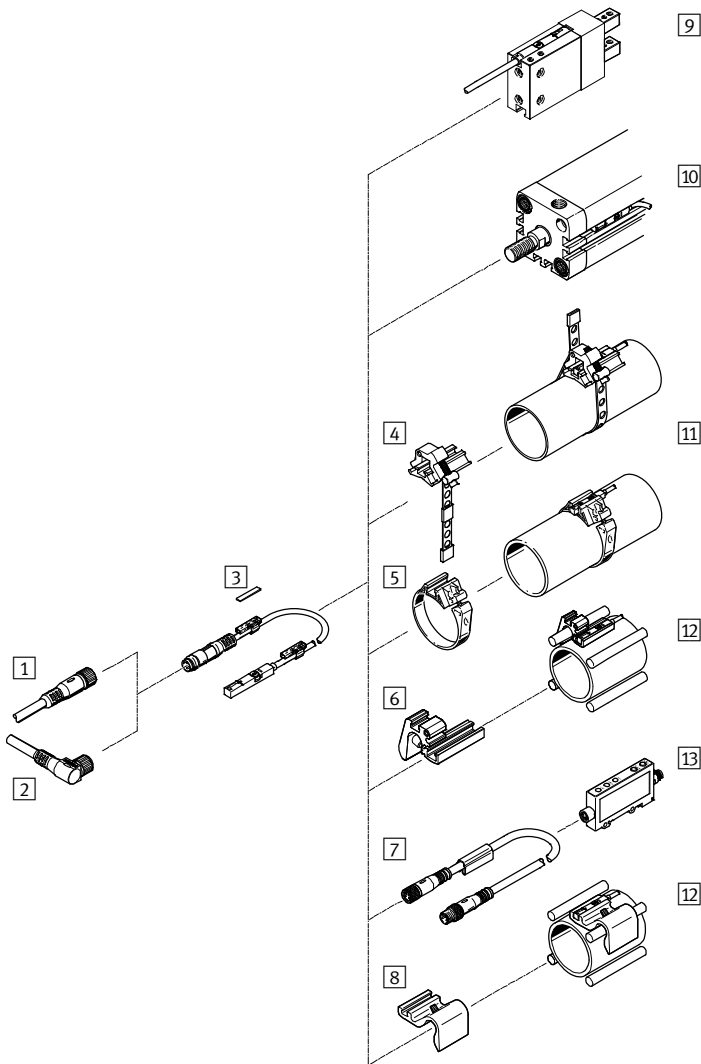

Accessories	→ Page/Internet
1 Connecting cable NEBU-M8G4	10
2 Connecting cable NEBU-M8W4	10
3 Inscription label ASLR	10
4 Mounting kit SMBR-8-8/100-S6, heat-resistant	10
5 Mounting kit SMBR	10
6 Mounting SMBZ-8	10
7 Connecting cable NEBU-M8G4	10
8 Sensor retainer DASP-M4-...	10
9 Three-point gripper DHDS	dhds
Three-point gripper HGDD	hgdd
Parallel gripper DHPS	dhps
Parallel gripper HGPD	hgpd
Parallel gripper HGPT	hgpt
Angle gripper DHWS	dhws
Radial gripper DHRS	dhrs
Radial gripper HGRT	hgrr

Accessories	→ Page/Internet
10 Standard cylinder DNCB	dncb
Standard cylinder DNC	dnc
Compact cylinder ADN	adn
Short-stroke cylinder ADVC/AEVC	advc
Compact cylinder ADVU/AEUV	advu
Flat cylinder DZF	dzf
Linear drive DGC	dgc
Linear/swivel clamp CLR	clr
Guided drive DFM	dfm
11 Standard cylinder/round cylinder DSNU	dsnu
Linear unit SLE	sle
12 Standard cylinder DSBG	dsbg
13 Signal converter SVE4	sve4

Position transmitters SMAT-8M, for T-slot

Type codes

SMAT - 8 M - U - E - 0,3 - M8D

Type	
SMAT	Position transmitter, magnetic
Design	
8	For T-slot
Sensor design	
M	Insertable in slot, centre clamping
Switching input/output	
U	0 ... 10 V
Cable characteristics	
E	Suitable for energy chains/robot applications
Cable length	
0,3	0.3 m
Electrical connection	
M8D	M8 plug, 4-pin, rotatable thread

Position transmitters SMAT-8M, for T-slot

Technical data

Function

Normal operation

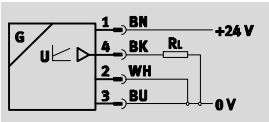

General technical data	
Design	For T-slot
Certification	c UL us - Listed (OL)
	RCM trademark
CE marking (see declaration of conformity)	To EU EMC Directive ¹⁾
Special features	Oil resistant
Note on materials	RoHS-compliant
	Halogen-free

- 1) For information about the applicability of the component see the manufacturer's EC declaration of conformity at: www.festo.com/sp → User documentation.
If the component is subject to restrictions on usage in residential, office or commercial environments or small businesses, further measures to reduce the emitted interference may be necessary.

Input signal/measuring element	
Measuring principle	Magnetic
Position measuring range [mm]	≤ 40 ²⁾

- 2) Depending on drive/gripper used.

Signal processing	
Max. speed of travel [m/s]	3

Output, general	
Displacement resolution [mm]	≤ 0.05 ²⁾
Repetition accuracy [mm]	±0.1 on cylinders ³⁾
	±0.025 on grippers ³⁾
[°]	±0.5 on semi-rotary drive DRRD

- 2) Depending on drive/gripper used.
3) Use of a non-rotating piston rod or a mechanical structure to protect against rotation is recommended.

Analogue output	
Typical linearity error [mm]	±1 on cylinders ²⁾
	±0.2 on grippers ²⁾

- 2) Depending on drive/gripper used.

Electrical outputs	
Analogue output [V]	0 ... 10
Protection against short circuit	Yes
Protection against overloading	Yes
Output signal	Analogue

Position transmitters SMAT-8M, for T-slot

Technical data

Electronics		
Operating voltage range	[V DC]	15 ... 30
Typical scanning interval	[ms]	2.8
Protection against polarity reversal		For all electrical connections
Electromechanics		
Electrical connection		Cable with plug, M8x1, knurled ring, 4-pin
Ambient temperature with flexible cable installation	[°C]	-5 ... +70
Cable length	[m]	0.3
Cable characteristics		Energy chain + robots
Cable test conditions		Energy chain: 50,000 cycles, bending radius 30 mm
		Torsional strength: >300,000 cycles, ±270°/0.1 m
		Resistance to bending: to Festo standard; test conditions on request
Information on materials for cable sheath		TPE-U(PUR)
Mechanical components		
Type of mounting		Secured with screw, insertable in the slot from above
Product weight	[g]	10
Information on housing materials		Reinforced PA6
Display/operation		
Status display		LED red, green
Immissions/emissions		
Ambient temperature	[°C]	-25 ... +75
Protection class		IP65, IP68
Corrosion resistance class	CRC ⁴⁾	2

4) Corrosion resistance class 2 as per Festo standard 940 070
Components subject to moderate corrosion stress. Externally visible parts with primarily decorative surface requirements which are in direct contact with a normal industrial environment or media such as coolants or lubricating agents.

Pin allocation		
Normal operation	Initialisation	Plug
		1 Operating voltage 2 Analogue output 0 V 3 0 V 4 Analogue output 0 ... 10 V
Wire colours		
BN = brown	BU = blue	
BK = black	WH = white	

Position transmitters SMAT-8M, for T-slot

Technical data

Dimensions Download CAD data → www.festo.com

- 1 Light emitting diode (LED)
- 2 Centre of the sensor element
- 3 Clamping component
- 4 Inscription label holder
- 5 Connecting cable
- 6 M8 plug, 4-pin, knurled ring

B1	D1	D2	D3	H1	L1	L2	L3	L4	L5	⌀
5	M8x1	9.6	2.9	4.6	300	34.8	31.8	41.1	23	1.5





Ordering data



Size	Analogue output [V]	Electrical connection	Cable length [m]	Part No.	Type
	0 ... 10	M8 plug, 4-pin, rotatable thread	0.3	553744	SMAT-8M-U-E-0,3-M8D

Position transmitters SMAT-8M, for T-slot

FESTO

Accessories

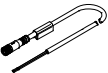
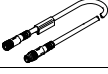
Ordering data – Mounting attachments			
	For piston diameter	Part No.	Type
Mounting kit SMBR-8-8/100-S6, heat-resistant			
	8 ... 100	538937	SMBR-8-8/100-S6
Mounting kit SMBR			
	8	175091	SMBR-8-8
	10	175092	SMBR-8-10
	12	175093	SMBR-8-12
	16	175094	SMBR-8-16
	20	175095	SMBR-8-20
	25	175096	SMBR-8-25
	32	175097	SMBR-8-32
	40	175098	SMBR-8-40
	50	175099	SMBR-8-50
63	175100	SMBR-8-63	
Mounting SMBZ			
	32 ... 100	537806	SMBZ-8-32/100
	125 ... 320	537808	SMBZ-8-125/320
Sensor retainer DASP-M4-...			
	For DSBG-125	1451483	DASP-M4-125-A
	For DSBG-250	1456781	DASP-M4-250-A
	For DSBG-320	3015256	DASP-M4-320-A

Ordering data – Connecting cable NEBU-M8				Technical data → Internet: nebu	
	Electrical connection, left	Electrical connection, right	Cable length [m]	Part No.	Type
	Straight socket, M8x1, 4-pin	Cable, open end, 4-wire	2.5	541342	NEBU-M8G4-K-2.5-LE4
			5	541343	NEBU-M8G4-K-5-LE4
	Straight socket, M8x1, 4-pin	Straight socket, M8x1, 4-pin	2.5	554035	NEBU-M8G4-K-2.5-M8G4
	Angled socket, M8x1, 4-pin	Cable, open end, 4-wire	2.5	541344	NEBU-M8W4-K-2.5-LE4
			5	541345	NEBU-M8W4-K-5-LE4

Ordering data – Inscription label ASLR				
	Size	Part No.	Type	PU ¹⁾
	23x4 mm	541598	ASLR-L-423	34

1) Packaging unit in quantity per frame

Festo North America

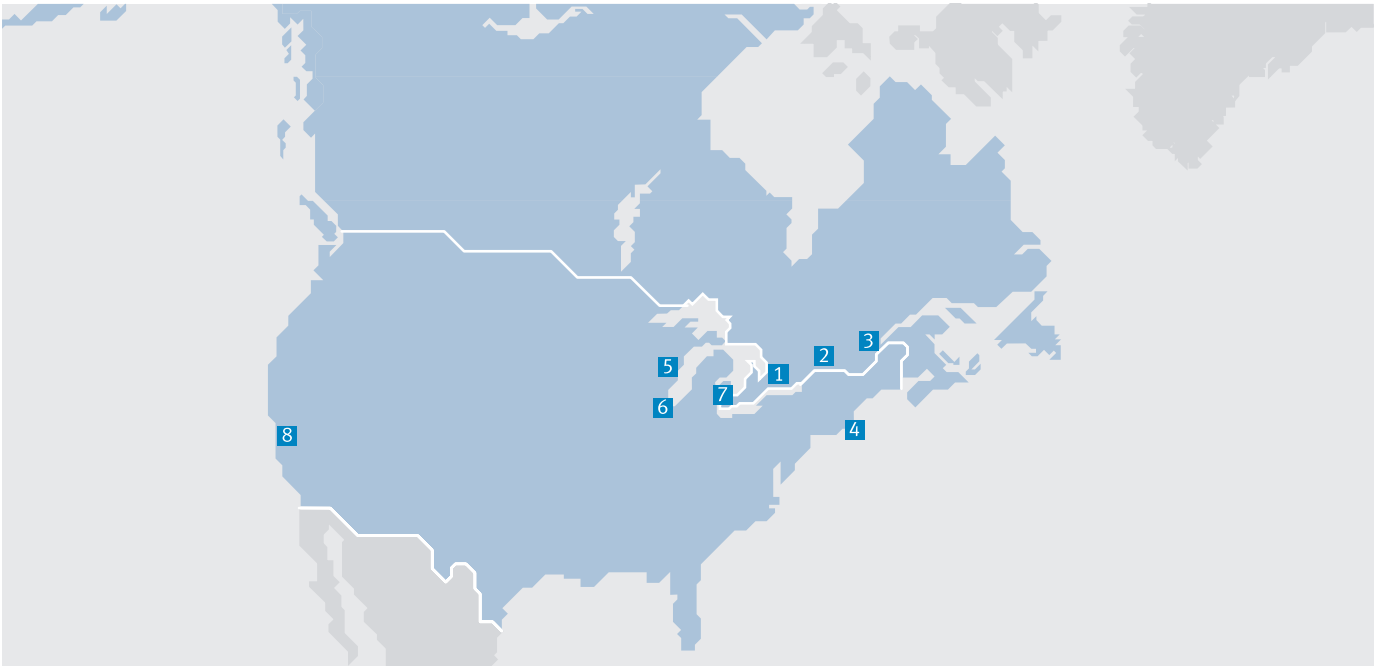

**1 Festo Canada
Headquarters
Festo Inc.**
5300 Explorer Drive
Mississauga, ON
L4W 5G4

2 Montréal
5600, Trans-Canada
Pointe-Claire, QC
H9R 1B6

3 Québec City
2930, rue Watt#117
Québec, QC
G1X 4G3



**4 Festo United States
Headquarters
Festo Corporation**
395 Moreland Road
Hauppauge, NY
11788

5 Appleton
North 922 Tower View Drive, Suite N
Greenville, WI
54942

7 Detroit
1441 West Long Lake Road
Troy, MI
48098

6 Chicago
85 W Algonquin - Suite 340
Arlington Heights, IL
60005

8 Silicon Valley
4935 Southfront Road, Suite F
Livermore, CA
94550

Festo Regional Contact Center

Canadian Customers

Commercial Support:
Tel: 1 877 GO FESTO (1 877 463 3786)
Fax: 1 877 FX FESTO (1 877 393 3786)
Email: festo.canada@ca.festo.com

Technical Support:
Tel: 1 866 GO FESTO (1 866 463 3786)
Fax: 1 877 FX FESTO (1 877 393 3786)
Email: technical.support@ca.festo.com

USA Customers

Commercial Support:
Tel: 1 800 99 FESTO (1 800 993 3786)
Fax: 1 800 96 FESTO (1 800 963 3786)
Email: customer.service@us.festo.com

Technical Support:
Tel: 1 866 GO FESTO (1 866 463 3786)
Fax: 1 800 96 FESTO (1 800 963 3786)
Email: product.support@us.festo.com