

End-position controllers SPC11



End-position controllers SPC11

Key features

At a glance

Fast travel between two fixed stops with electronic end-position cushioning and up to two freely selectable intermediate positions.

- Up to 30% faster cycle rate
- Significantly reduced system vibration
- Fast problem-free commissioning, no specialists required
- Simple conversion of existing systems
- Optimum operating behaviour is maintained even with changes in weight/load of up to 30% of the total moving mass
- Less expensive than electromechanical drives
- Reduced noise level

Individual components

End-position controller

Integrated functions:

- Determining system characteristic values of the connected components.
- Storage of the desired end positions or intermediate positions.

- Comparison of setpoint and actual position, and position control through appropriate actuation of the proportional 5/3-way valve (status control).
- Internal or external teach-in function.

SPC11



Analogue displacement encoders

Analogue position encoder based on a conductive-plastic linear potentiometer. The system measures absolute values. It is connected alongside a pneumatic drive. Mounting kits are

available as accessories for the mechanical coupling. The displacement encoder is available in fixed stroke lengths graduated from 100 ... 2000 mm.

MLO-POT...-TLF



MLO-POT...-LWG



Digital displacement encoders

Digital displacement encoders, magnetostrictive, contactless method of measurement. The system measures absolute values. It is connected alongside a pneumatic drive. Mounting kits

are available as accessories for the mechanical coupling. The displacement encoder is available in fixed stroke lengths graduated from 100 ... 2000 mm.

MME-MTS...-AIF



Pneumatic drives

Pneumatic drives ensure an easy-to-operate system. The stroke length operating range depends on the selected drive. It is in the range from 225 ... 2000 mm. The swivel angle with the DSMI ranges from 0° ... 270°.

 Note
Above a cylinder working stroke of 600 mm, drives DGCI with supply port (D2) on both sides must be used.

DGCI



DDLI



DNC



DNCI



DSMI



Proportional 5/3-way valves

Valve actuation is via the end-position controller. The valve controls the volume of air supplied to the drive. The extremely short switching time of the valve makes the Soft Stop solution package highly dynamic.

 Note
Use a 5 µm filter for air preparation. The compressed air supply must be unlubricated.

MPYE-5...-010B

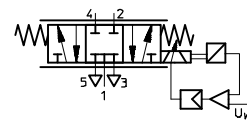

End-position controllers SPC11

Key features

Possible combinations

With external displacement encoder

End-position controller

Displacement encoder

Drive

SPC11
with I/O interface
→ 10



MLO-POT-...-TLF

MME-MTS-...-AIF

MLO-
POT-...-LWG

DGC-KF

DNC

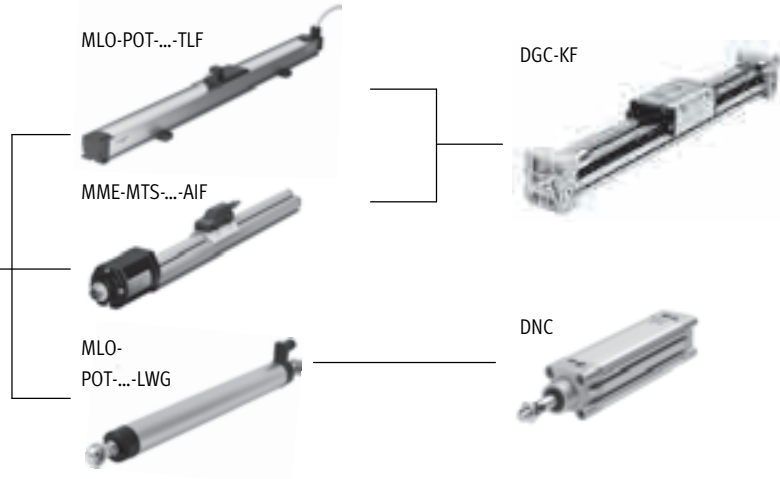

With external/integrated displacement encoder

End-position controller

Drive with displacement encoder

DDLI

DGCI

DNCI

DSMI

SPC11
with I/O interface
→ 10

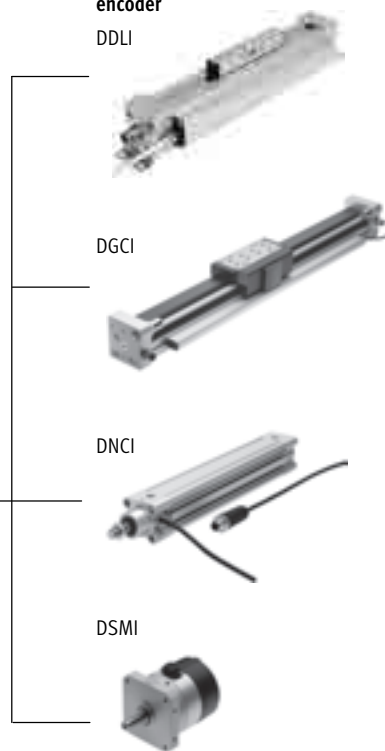

End-position controllers SPC11

Key features

FESTO

Conventional solution

Previously you needed to

- Harmonise individual components.
- Install additional shock absorbers and possibly replace/exchange existing shock absorbers.
- Fit proximity sensors for position detection.
- Adjust the compressed air supply by means of flow control valves in order to optimise the system.

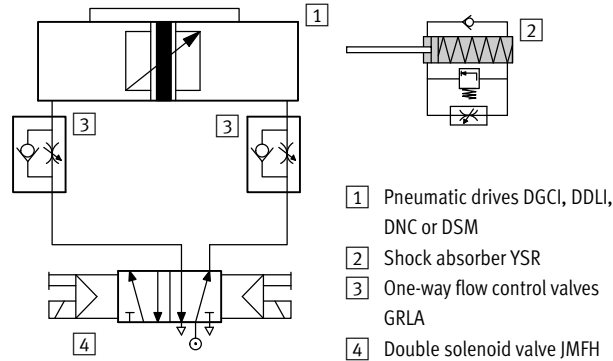

Previously, to create intermediate positions you had to

- Construct a complex mechanical solution yourself using stopper cylinders, for example.
- Harmonise a large number of individual components.
- Carry out extensive programming.

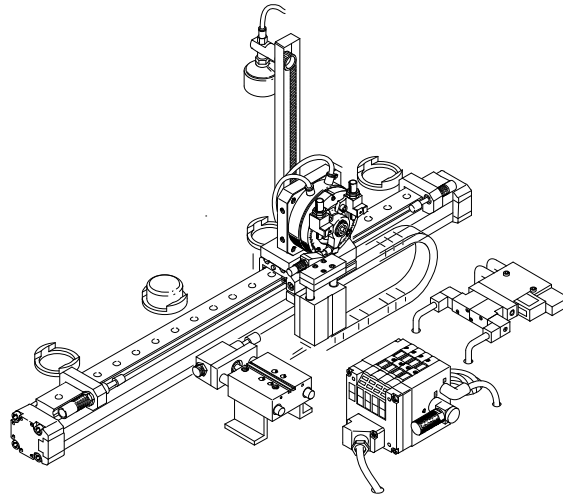

Solution with end-position controller SPC11

Fast travel between two fixed stops with up to two freely selectable intermediate positions

The Soft Stop system with end-position controller SPC11 facilitates travel to up to two freely selectable intermediate positions as well as travel between two fixed mechanical stops. The accuracy of the intermediate positions is $\pm 0.25\%$ of the length of

the displacement encoder, with the minimum being ± 2 mm. In the case of the semi-rotary drive DSMI, the accuracy of the intermediate positions is $\pm 2\%$. Typical applications for the intermediate positions are wait or ejector positions, where a low-cost

solution is more important than achieving high levels of accuracy. The mid-positions also have sensor functionality. In other words, if the respective mid-position is overshoot, a 1 signal is supplied to the corresponding output for 50 ms.

End-position controllers SPC11

Key features

The Festo solution package

Soft Stop with end-position controller SPC11

In an application with up to two intermediate positions you can now:

- Use the Festo solution package with a small number of harmonised components.
- Dispense with complex constructions using stopper cylinders.
- Approach the intermediate positions from both sides.
- Let optimisation be carried out by the learning system itself.

The Soft Stop system with SPC11 has a remote input which allows all 3 buttons to be positioned on a higher-order controller:

- All system parameters can be defined and changed externally.
- A 1 signal at the remote input locks all buttons on the end-position controller SPC11.

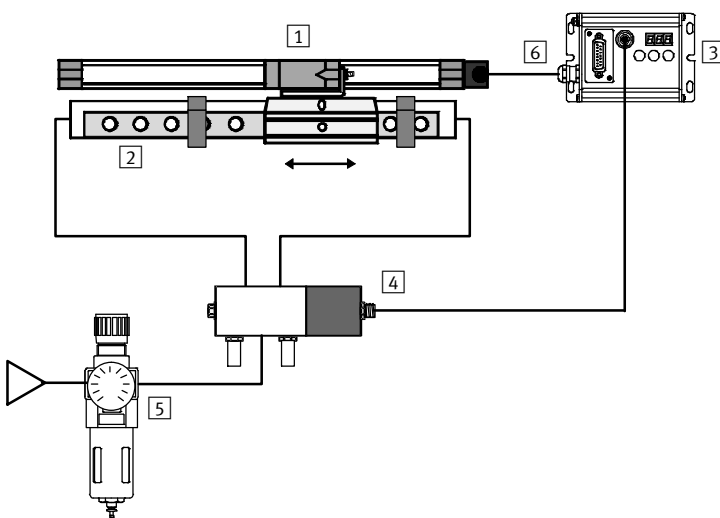

- | | |
|--|---|
| <p>1 Displacement encoder</p> <p>Digital:</p> <ul style="list-style-type: none"> – MME-MTS-...-AIF – integrated in DNCI <p>Analogue:</p> <ul style="list-style-type: none"> – MLO-POT-...-TLF – MLO-POT-...-LWG – integrated in DSMI <p>2 Pneumatic drives</p> <p>DGCI, DGC-KF, DNC, DNCI, DDLI or DSMI</p> | <p>3 End-position controller</p> <p>SPC11-POT-TLF,
SPC11-POT-LWG or
SPC11-MTS-AIF
SPC11-INC</p> <p>4 Proportional 5/3-way valve</p> <p>MPYE-5-...-010B</p> <p>5 Service unit (without lubricator, with 5 µm filter); supply pressure 5 to 7 bar</p> <p>6 Operating voltage port and higher-order controller</p> |
|--|---|

End-position controllers SPC11

Key features

The solution package

Individual components

- Pneumatic drives
DGC1, DGC-KF, DNC, DNCl,
DDL1 or DSM1
- Proportional 5/3-way valve
MPYE-5-...-010B
- Displacement encoder
MLO-POT-...-TLF,
MLO-POT-...-LWG or
MME-MTS-...-AIF
- End-position controller
SPC11
- Valve cable
KMPYE
- Controller cable
KMPV-...
- Manual

The solution packages are clearly defined, i.e. all components are precisely matched to one another. For a clear overview, please see → 27 or Soft Stop engineering software:
→ www.festo.com

Accessories available to order separately (fittings, tubing, etc.) can be found in the respective solution packages. The order examples → 26 are for explanatory purposes.

PPV = Open the internal cushioning 100%

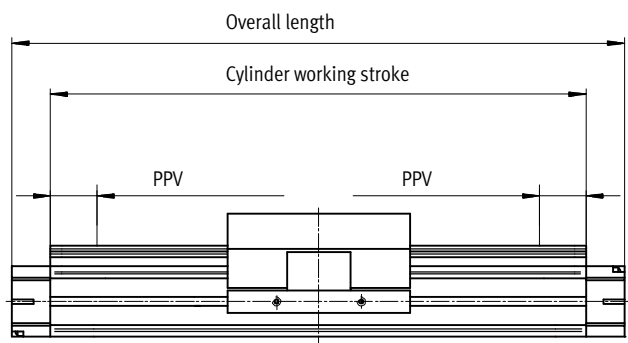

Symmetric

The desired travel distance should not therefore exceed the relevant cylinder working stroke.

The following thus applies:
travel distance ≤ cylinder working stroke.

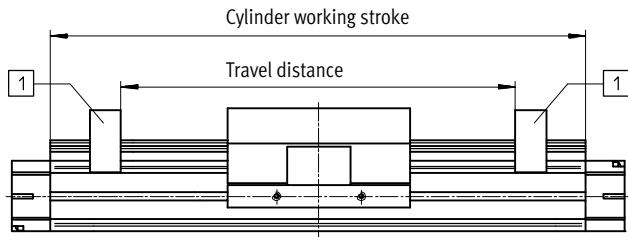

1 Fixed stops, mounted on drive or external

Asymmetrical

The desired travel distance within the cylinder working stroke must be limited by means of fixed stops.

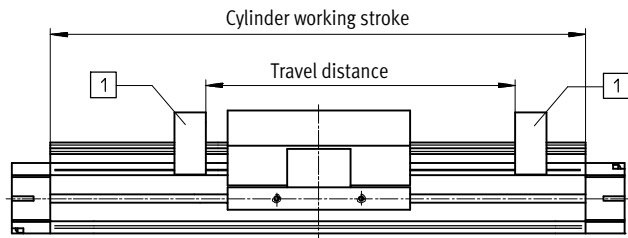

1 Fixed stops, mounted on drive or external

Note

In order to achieve the working stroke together with the Soft Stop system, when using the pneumatic drive DDL1 external stop elements are required.

End-position controllers SPC11

Key features

The solution package

Benefits

- Up to 30% faster cycle rate
- Significantly reduced system vibration
- Optimum operating behaviour is maintained even with changes in weight/load of up to 30% of the total moving mass
- Simple conversion of existing systems
- Considerably reduced noise level
- Fast problem-free commissioning, no specialists required
- Less expensive than electromechanical drives

The graphs apply to the following example:

- DGCI-25-1250-KF-Q,
- moving mass 12 kg,
- horizontal mounting position

Note

The course of the curve is identical for pneumatic drives DGC-K, DNC, DNCI, DDLI and DSML.

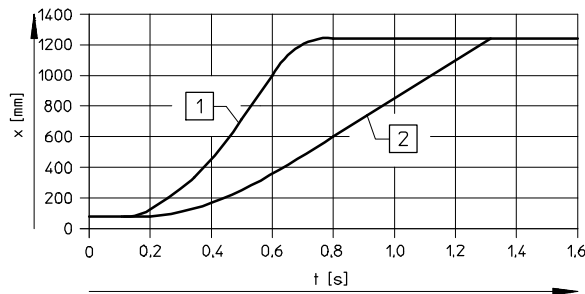

- 1 = Drive with electronic end-position controller SPC11
- 2 = Drive with shock absorber

x = Travel distance
t = Time

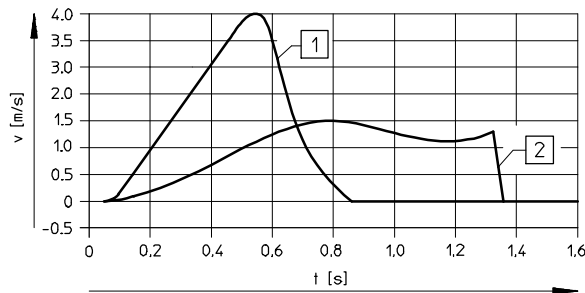

- 1 = Drive with electronic end-position controller SPC11
- 2 = Drive with shock absorber

v = Speed
t = Time

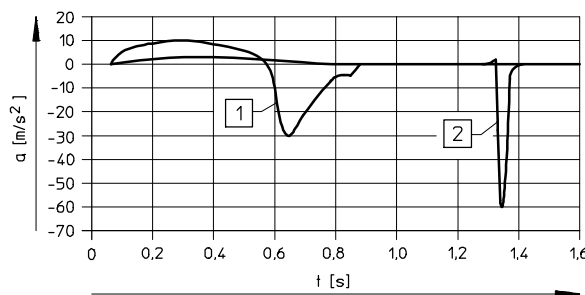

- 1 = Drive with electronic end-position controller SPC11
- 2 = Drive with shock absorber

a = Acceleration
t = Time

Festo plug & work = Commissioning in just a few steps

- 1 Mount system components: Moving mass must be installed without backlash.
- 2 Set up the pneumatic and electrical system connections.
- 3 Switch on the compressed air and supply voltage.
- 4 Press a button to start the teach-in process. The system learns autonomously and is ready for operation after 3 minutes.
- 5 Approach and save intermediate positions by using the buttons.

End-position controllers SPC11

Peripherals overview

FESTO

Variant with drive DNCI

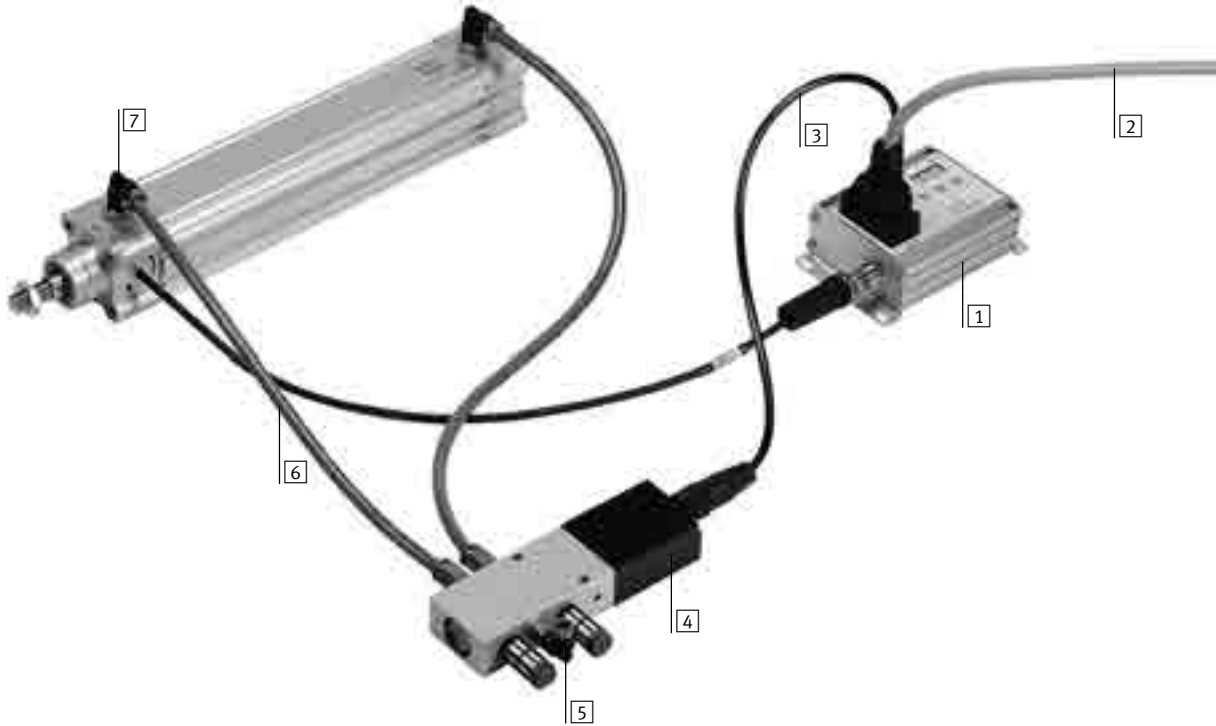

End-position controllers SPC11

Peripherals overview

Individual components				
Description	Pneumatic drives			
	DGCI/DDLI	DNC	DNCI	DSMI
1 End-position controller SPC11	■	■	■	■
2 Connecting cable to controller	■	■	■	■
3 Connecting cable KMPYE to proportional 5/3-way valve	■	■	■	■
4 Proportional 5/3-way valve MPYE	■	■	■	■
5 Compressed air supply	■	■	■	■
6 Tubing	■	■	■	■
7 Fitting QS	■	■	■	■
- Fixed stop	■	1)	1)	■
Analogue displacement encoder MLO-POT-...-LWG	-	■	-	-
Solution packages →	12	18	22	26

1) For DNC and DNCI, external stop elements are required in order to limit the travel distance within the working stroke.

Allocation of end-position controller SPC11 to drive and displacement encoder					
End-position controller	SPC11-POT-TLF	SPC11-POT-LWG	SPC11-MTS-AIF	SPC11-INC	SPC11-MTS-AIF-2
Drive					
DGCI/DDLI	-	-	-	-	■
DNCI	-	-	-	■	-
DSMI	-	■	-	-	-
Displacement encoder					
MLO-POT-TLF	■	-	-	-	-
MLO-POT-LWG	-	■	-	-	-
MME-MTS-AIF	-	-	■	-	-

End-position controllers SPC11

Technical data

FESTO

Teach-in function

SPC11-POT-TLF
 SPC11-POT-LWG
 SPC11-MTS-AIF
 SPC11-INC
 SPC11-MTS-AIF-2

Teach-in travel to determine the system characteristic values and end positions can be started either using a button on the end-position controller SPC11 or via an output (e.g. of the PLC) externally routed via the control cable.

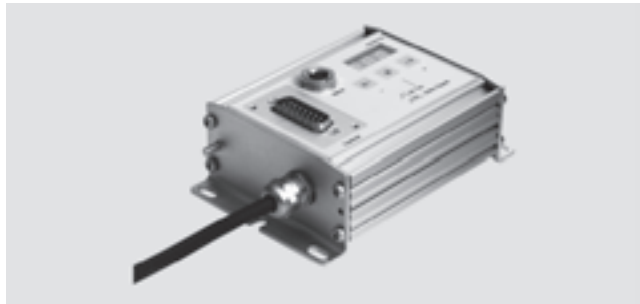

General technical data								
End-position controllers SPC11-...		Type	...-POT-TLF	...-POT-LWG	...-MTS-AIF	...-INC	...-MTS-AIF-2	
Operating voltage		[V DC]	24 (-25 ... +25%)					
Current consumption	with valve	[A]	1.3					1.1
	without valve	[mA]	70		170	80	70	
Residual ripple		[%]	Max. 5					
Digital inputs	Number		8					
	Input voltage	[V DC]	24					
	Input current	[mA]	4 (at 24 V DC)					
	Duty cycle	[ms]	Min. 20					
	Signal voltage	[V DC]	0 ... 5 (for logical 0) 15 ... 30 (for logical 1)					
Digital outputs (short-circuit proof)	Number		5					
	Output voltage		min. U_b ... U_b : -3 V DC (at 0.1 A)					
	Output current	[A]	Max. 0.1					
	Max. tripping current	[mA]	500					
Displacement encoder input MLO-POT-...	Operating voltage	[V DC]	+10		-			
	Input voltage	[V DC]	0 ... +10		-			
Displacement encoder input MME-MTS-...	Operating voltage	[V DC]	-		24	-		
	Communication		-		CAN fieldbus (1 Mbaud)	-		
Standard cylinder input DNCl	Operating voltage	[V DC]	-		5		-	
	Communication		-		sin/cos		-	
Linear drive input DGCl	Operating voltage	[V DC]	-		24			
	Communication		-		CAN fieldbus (1 Mbaud)			
Valve output	Operating voltage	[V DC]	24					
Valve output	Output voltage	[V DC]	0 ... +10					
Relative air humidity		[%]	95 (non-condensing)					
Weight		[g]	Approx. 400					

Operating and environmental conditions								
End-position controllers SPC11-...		Type	...-POT-TLF	...-POT-LWG	...-MTS-AIF	...-INC	...-MTS-AIF-2	
Temperature range		[°C]	0 ... +50					
Degree of protection to IEC 60529			IP65					
Vibration resistance, tested to DIN/IEC 68, Part 2-6			Severity level 2					
Shock resistance, tested to DIN/IEC 68, Part 2-27			Severity level 2					
CE marking (see declaration of conformity)			To EU EMC Directive					

End-position controllers SPC11

Technical data

Dimensions

Download CAD data → www.festo.com

SPC11-POT-TLF, SPC11-POT-LWG, SPC11-MTS-AIF

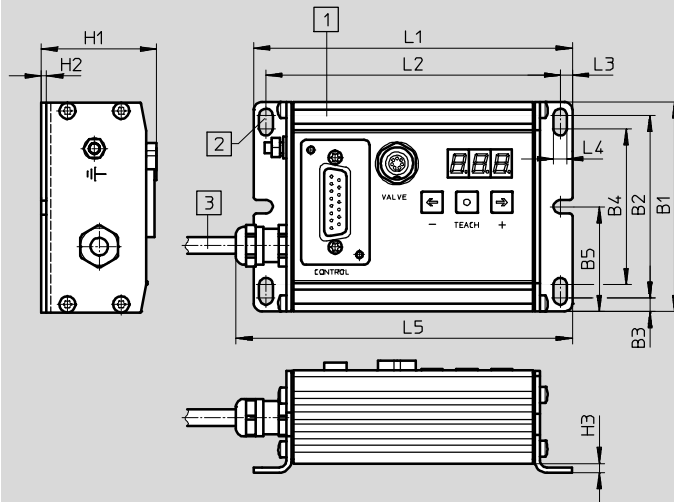

- 1 Slot for inscription labels:
18182 IBS-9x20
18576 IBS-6x10
- 2 Mounting options for M4 screws
- 3 Connecting cable
(length approx. 335 mm)

SPC11-INC, SPC11-MTS-AIF-2

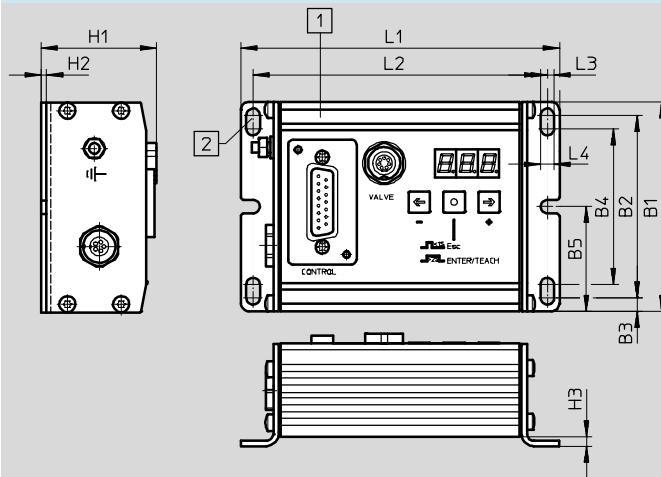

- 1 Slot for inscription labels:
18182 IBS-9x20
18576 IBS-6x10
- 2 Mounting options for M4 screws

Type	B1	B2	B3	B4	B5	H1	H2	H3	L1	L2	L3	L4	L5
SPC11-POT-...	78	68	5	58	39	43	2	4.5	118.1	109.1	4.5	5	125
SPC11-MTS-AIF						42.6		4.2					-
SPC11-MTS-AIF-2						-		-					-
SPC11-INC						-		-					-

Ordering data

Designation	Part No.	Type
For analogue displacement encoder MLO-POT-...-TLF	192216	SPC11-POT-TLF
For analogue displacement encoder MLO-POT-...-LWG, semi-rotary drive DSMI	192217	SPC11-POT-LWG
For digital displacement encoder MME-MTS-...-AIF	192218	SPC11-MTS-AIF
For standard cylinder DNCI	537321	SPC11-INC
For linear drive DCGI/DDLI	548129	SPC11-MTS-AIF-2

End-position controllers SPC11

Technical data

Order example for the pneumatic linear drives DGCI/DDLI

A workpiece weighing 3 kg must be conveyed horizontally on a loading station. The workpiece gripper

mounted on the slide unit of the drive weighs 14 kg. The total weight to be weighed is thus 17 kg. The distance to

be travelled is 1100 mm. The travel time should be < 1.5 seconds.

Step 1:

Determine the cylinder stroke

For a travel distance of 1100 mm, the nearest cylinder working stroke greater than this of 1250 mm should be selected from the table → 13. This column has a grey background.

Step 2:

Specify the drive

For the total mass of 17 kg to be moved horizontally, there is a choice of piston diameter of 25, 32 and 40 mm (see in each case the maximum total mass to be moved). For the example, the selected drive is a DGCI-32-1250-KF... with part number 544427.

Step 3:

Specify a proportional 5/3-way valve

The appropriate proportional 5/3-way valve can be found at the intersection of the grey column in step 1 and the row for the linear drive DGCI-32-... selected, in the table area “Proportional 5/3-way valve”. In the case of our example, this is the proportional 5/3-way valve MPYE-5-1/4-010B with the part number 151694.

Step 4:

Complete the order information

To order a complete system you must add the order data for the end-position controller, valve and controller cables and manual (if required). The complete ordering data for the example described can be found → 13. A manual should normally be ordered. If you already have one, leave the appropriate box blank, indicating an express waiver of a manual.

Step 5:

Determine the travel time

To determine the travel time, use the “Soft Stop” software tool. In the order example, the travel time is 1.16 seconds.



Note

Engineering software
Soft Stop and ProDrive
→ www.festo.com



Note

When selecting drive mounting components, please note that these are often not backlash-free and therefore cannot be used in conjunction with the Soft Stop system. The drives must be mounted directly.



Note

Check that the loads placed on the drive by the workpiece gripper during the movement process do not exceed permissible limits.

To perform a simulation quickly and easily, use the Smart Soft Stop software tool and ProDrive.



Note

For vertical travel, there are two different travel times for t_{up} and t_{down} .

Ordering data					
Pneumatic linear drive		Proportional 5/3-way valve		End-position controller	
Part No.	Type	Part No.	Type	Part No.	Type
544427	DGCI-32-1250-KF-...	151694	MPYE-5-1/4-010B	548129	SPC11-MTS-AIF-2

Valve cable		Controller cable	
Part No.	Type	Part No.	Type
170238	KMPYE-AIF-1-GS-GD-2	177674	KMPV-SUB-D-15-10

End-position controllers SPC11

Technical data

Step 1 and 2:		Pneumatic linear drives/Type													
Pneumatic linear drives/Type		DGCI-... ¹⁾ -... ²⁾ -KF-... DDLI													
Cylinder working stroke	[mm]	100	160	225	300	360	450	500	600	750	1000	1250	1500	1750	2000
Max. overall mass to be moved horizontally/vertically with Ø	18	15/5													
	25	30/10													
	32	45/15													
	40	70/25													
Part No. for Ø	18	544425													
	25	544426													
	32	544427													
	40	544428													

Step 3:		Proportional 5/3-way valves ³⁾													
Part No./Type		1 = 154200 MPYE-5-M5-010-B							3 = 151693 MPYE-5-1/8-HF-010-B						
		2 = 151692 MPYE-5-1/8-LF-010-B							4 = 151694 MPYE-5-1/4-010-B						
Cylinder working stroke	[mm]	100	160	225	300	360	450	500	600	750	1000	1250	1500	1750	2000
Horizontally/vertically for Ø	18	1/1	1/1	1/1	1/1	2/2	2/2	2/2	2/2	2/2	2/2	2/2	2/2	2/2	3/3
	25	2/2	2/2	2/2	2/2	3/2	3/2	3/2	3/2	3/2	3/3	3/3	3/3	3/3	3/3
	32	2/2	3/2	3/2	3/2	3/3	3/3	3/3	3/3	3/3	3/3	4/3	4/3	4/3	4/4
	40	3/2	3/2	3/2	3/3	3/3	3/3	3/3	4/3	4/3	4/3	4/4	4/4	4/4	4/4

Step 5:		Part No.		Type	Brief description
End-position controller	SPC11	548129		SPC11-MTS-AIF-2	
Cable	Valve	170238		KMPYE-AIF-1-GS-GD-2	Cable length 2 m
		170239		KMPYE-AIF-1-GS-GD-0,3	Cable length 0.3 m
	SPC11/PLC	177673		KMPV-SUB-D-15-5	Cable length 5 m
		177674		KMPV-SUB-D-15-10	Cable length 10 m

 Note
Manuals → 31

- 1) Specify diameter. Technical data and dimensions → Internet: dgci/ddli
- 2) Specify cylinder working stroke determined.
- 3) Technical data and dimensions → Internet: mpye

End-position controllers SPC11

Technical data

FESTO

Accessories for solution package for horizontal mounting position with DGCI/DDLI

For cylinder working stroke 100 ... 2000 mm

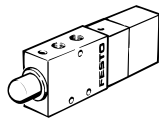
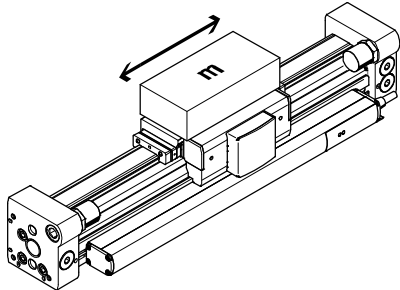

Ordering data									
Cylinder working stroke DGCI/DDLI [mm]	Proportional 5/3-way valve Type	Fittings ¹⁾				Tubing		Silencer ²⁾	
		For MPYE-5-...		For DGCI/DDLI		Part No.	Type	Part No.	Type
		Part No.	Type	Part No.	Type				
DGCI									
Ø 18									
100 ... 160	MPYE-5-M5-010-B	153306	QSM-M5-6	153306	QSM-M5-6	152586	PUN-6x1-SI	165003	UC-M5
225 ... 300	MPYE-5-M5-010-B								
360 ... 1750	MPYE-5-1/8-LF-010-B	153002	QS-1/8-6	153306	QSM-M5-6	152586	PUN-6x1-SI	2307	U-1/8
2000	MPYE-5-1/8-HF-010-B								
DGCI/DDLI									
Ø 25									
100 ... 160	MPYE-5-1/8-LF-010-B	153002	QS-1/8-6	153002	QS-1/8-6	152586	PUN-6x1-SI	2307	U-1/8
225 ... 300	MPYE-5-1/8-LF-010-B	153004	QS-1/8-8	153004	QS-1/8-8	152587	PUN-8x1,25-SI	2307	U-1/8
360 ... 2000	MPYE-5-1/8-HF-010-B								
Ø 32									
100	MPYE-5-1/8-LF-010-B	153002	QS-1/8-6	153002	QS-1/8-6	152586	PUN-6x1-SI	2307	U-1/8
160 ... 1000	MPYE-5-1/8-HF-010-B	153004	QS-1/8-8	153004	QS-1/8-8	152587	PUN-8x1,25-SI		
1250 ... 2000	MPYE-5-1/4-010-B	153005	QS-1/4-8					2316	U-1/4
Ø 40									
100 ... 160	MPYE-5-1/8-HF-010-B	153004	QS-1/8-8	153005	QS-1/4-8	152587	PUN-8x1,25-SI	2307	U-1/8
225 ... 500	MPYE-5-1/8-HF-010-B								
600 ... 750	MPYE-5-1/4-010-B	153005	QS-1/4-8	153005	QS-1/4-8	152587	PUN-8x1,25-SI	2316	U-1/4
1000 ... 2000	MPYE-5-1/4-010-B	153007	QS-1/4-10	153007	QS-1/4-10	152588	PUN-10x1,5-SI	2316	U-1/4
Ø 63									
100 ... 300	MPYE-5-1/8-HF-010-B	153004	QS-1/8-8	153005	QS-3/8-8	152587	PUN-8x1,25-SI	2307	U-1/8
360 ... 450	MPYE-5-1/4-010-B	153007	QS-1/4-10	153008	QS-3/8-10	152588	PUN-10x1,5-SI	2316	U-1/4
500 ... 2000	MPYE-5-3/8-010-B	153009	QS-3/8-12	153009	QS-3/8-12	152589	PUN-12x2-SI	2309	U-3/8

1) Fittings are only supplied in batches of 10.

2) 2 of these are required.

End-position controllers SPC11

Technical data

FESTO

Accessories for solution package for horizontal mounting position with DGCI/DDLI

For cylinder working stroke 100 ... 2000 mm

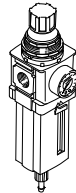
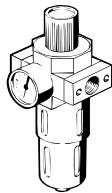

Ordering data								
Cylinder working stroke DGCI/DDLI [mm]	Filter regulator, D series with filter cartridge 5 mm		Filter cartridge 5 mm D series		Filter regulator, MS series with filter cartridge 5 µm		Filter cartridge 5 mm MS series	
	Part No.	Type	Part No.	Type	Part No.	Type	Part No.	Type
DGCI								
Ø 18								
100 ... 2000	162719	LFR-¼-D-5M-MINI	159640	LFP-D-MINI-5M	529152	MS4-LFR-¼-D7-CRM-AS	534501	MS4-LFP-C
DGCI/DDLI								
Ø 25								
100 ... 2000	162719	LFR-¼-D-5M-MINI	159640	LFP-D-MINI-5M	529152	MS4-LFR-¼-D7-CRM-AS	534501	MS4-LFP-C
Ø 32								
100 ... 1000	162719	LFR-¼-D-5M-MINI	159640	LFP-D-MINI-5M	529152	MS4-LFR-¼-D7-CRM-AS	534501	MS4-LFP-C
1250 ... 2000	162721	LFR-¾-D-5M-MIDI	159594	LFP-D-MIDI-5M	529204	MS6-LFR-¼-D7-CRM-AS	534499	MS6-LFP-C
Ø 40								
100 ... 500	162719	LFR-¼-D-5M-MINI	159640	LFP-D-MINI-5M	529152	MS4-LFR-¼-D7-CRM-AS	534501	MS4-LFP-C
600 ... 2000	162721	LFR-¾-D-5M-MIDI	159594	LFP-D-MIDI-5M	529204	MS6-LFR-¼-D7-CRM-AS	534499	MS6-LFP-C
Ø 63								
100 ... 360	162719	LFR-¼-D-5M-MINI	159640	LFP-D-MINI-5M	529152	MS4-LFR-¼-D7-CRM-AS	534501	MS4-LFP-C
450 ... 600	162721	LFR-¾-D-5M-MIDI	159594	LFP-D-MIDI-5M	529204	MS6-LFR-¼-D7-CRM-AS	534499	MS6-LFP-C
600 ... 2000	162724	LFR-¾-D-5M-MAXI	159641	LFP-D-MAXI-5M	529224	MS6-LFR-¾-D7-CRM-AS		

End-position controllers SPC11

Technical data

FESTO

Accessories for solution package for vertical mounting position with DGCI/DDLI

For cylinder working stroke 100 ... 2000 mm

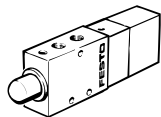
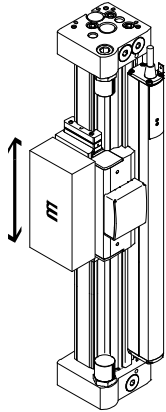

Ordering data									
Cylinder working stroke DGCI/DDLI [mm]	Proportional 5/3-way valve Type	Fittings ¹⁾				Tubing		Silencer ²⁾	
		For MPYE-5-...		For DGCI/DDLI		Part No.	Type	Part No.	Type
		Part No.	Type	Part No.	Type				
DGCI									
Ø 18									
100 ... 300	MPYE-5-M5-010-B	153306	QSM-M5-6	153306	QSM-M5-6	152586	PUN-6x1-SI	165003	UC-M5
360 ... 1750	MPYE-5-1/8-LF-010-B	153002	QS-1/8-6					2307	U-1/8
2000	MPYE-5-1/8-HF-010-B								
DGCI/DDLI									
Ø 25									
100 ... 160	MPYE-5-1/8-LF-010-B	153002	QS-1/8-6	153002	QS-1/8-6	152586	PUN-6x1-SI	2307	U-1/8
225 ... 750	MPYE-5-1/8-LF-010-B	153004	QS-1/8-8	153004	QS-1/8-8	152587	PUN-8x1,25-SI		
1000 ... 2000	MPYE-5-1/8-HF-010-B								
Ø 32									
100	MPYE-5-1/8-LF-010-B	153002	QS-1/8-6	153002	QS-1/8-6	152586	PUN-6x1-SI	2307	U-1/8
160 ... 300	MPYE-5-1/8-LF-010	153004	QS-1/8-8	153004	QS-1/8-8	152587	PUN-8x1,25-SI	2307	U-1/8
360 ... 1750	MPYE-5-1/8-HF-010								
2000	MPYE-5-1/4-010-B	153005	QS-1/4-8					2316	U-1/4
Ø 40									
100 ... 225	MPYE-5-1/8-LF-010	153004	QS-1/8-8	153005	QS-1/4-8	152587	PUN-8x1,25-SI	2307	U-1/8
300 ... 750	MPYE-5-1/8-HF-010								
1000	MPYE-5-1/8-HF-010	190643	QS-1/8-10	153007	QS-1/4-10	152588	PUN-10x1,5-SI		
1250 ... 2000	MPYE-5-1/4-010-B	153007	QS-1/4-10					2316	U-1/4
Ø 63									
100 ... 225	MPYE-5-1/8-LF-010	153004	QS-1/8-8	153005	QS-3/8-8	152587	PUN-8x1,25-SI	2307	U-1/8
300	MPYE-5-1/8-HF-010								
360 ... 450	MPYE-5-1/4-010-B	190643	QS-1/8-10	153007	QS-3/8-10	152588	PUN-10x1,5-SI	2316	U-1/4
500 ... 2000	MPYE-5-3/8-010	153009	QS-3/8-12	153009	QS-3/8-12	152589	PUN-12x2-SI	2309	U-3/8

1) Fittings are only supplied in batches of 10.

2) 2 of these are required.

End-position controllers SPC11

Technical data

FESTO

Accessories for solution package for vertical mounting position with DGCI/DDLI

For cylinder working stroke 100 ... 2000 mm

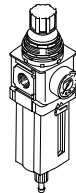
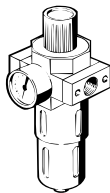

Ordering data								
Cylinder working stroke DGCI/DDLI [mm]	Filter regulator, D series with filter cartridge 5 mm		Filter cartridge 5 mm D series		Filter regulator, MS series with filter cartridge 5 mm		Filter cartridge 5 mm MS series	
	Part No.	Type	Part No.	Type	Part No.	Type	Part No.	Type
DGCI								
Ø 18								
100 ... 2000	162719	LFR-¼-D-5M-MINI	159640	LFP-D-MINI-5M	529152	MS4-LFR-¼-D7-CRM-AS	534501	MS4-LFP-C
DGCI/DDLI								
Ø 25								
100 ... 2000	162719	LFR-¼-D-5M-MINI	159640	LFP-D-MINI-5M	529152	MS4-LFR-¼-D7-CRM-AS	534501	MS4-LFP-C
Ø 32								
100 ... 1000	162719	LFR-¼-D-5M-MINI	159640	LFP-D-MINI-5M	529152	MS4-LFR-¼-D7-CRM-AS	534501	MS4-LFP-C
1250 ... 2000	162721	LFR-¾-D-5M-MIDI	159594	LFP-D-MIDI-5M	529204	MS6-LFR-¼-D7-CRM-AS	534499	MS6-LFP-C
Ø 40								
100 ... 500	162719	LFR-¼-D-5M-MINI	159640	LFP-D-MINI-5M	529152	MS4-LFR-¼-D7-CRM-AS	534501	MS4-LFP-C
Ø 63								
100 ... 360	162719	LFR-¼-D-5M-MINI	159640	LFP-D-MINI-5M	529152	MS4-LFR-¼-D7-CRM-AS	534501	MS4-LFP-C
450 ... 600	162721	LFR-¾-D-5M-MIDI	159594	LFP-D-MIDI-5M	529204	MS6-LFR-¼-D7-CRM-AS	534499	MS6-LFP-C
600 ... 2000	162724	LFR-¾-D-5M-MAXI	159641	LFP-D-MAXI-5M	529224	MS6-LFR-¾-D7-CRM-AS		

End-position controllers SPC11

Technical data

Order example for the pneumatic drive DNC with linear potentiometer LWG

A workpiece weighing 55 kg must be conveyed horizontally on a loading station. The workpiece gripper

mounted on the piston rod of the drive weighs 40 kg. The total weight to be weighed is thus 95 kg. The distance to

be travelled is 300 mm. The travel time should be < 1.5 seconds.

Step 1: Determine the cylinder stroke

For a travel distance of 300 mm, the nearest standard stroke greater than this of 320 mm or the cylinder working stroke of 291 ...350 mm should be selected from the table → 19. This column has a grey background.

Step 2: Specify the drive

For the total mass of 95 kg to be moved horizontally, there is a choice of piston diameter of 50, 63 and 80 mm (see in each case the maximum total mass to be moved). For the example, the selected drive is a DNC-50-320-PPV-A with part number 163378.

Step 3: Specify the linear potentiometer

The appropriate linear potentiometer can be determined from the allocation cylinder working stroke ≤ length of linear potentiometer. The column with the grey background in the Displacement encoder section of the table shows part number 152647 for this example.

 - Note
The linear potentiometer is enclosed separately and must be fitted by the customer.

Step 4: Specify a proportional 5/3-way valve

The appropriate proportional 5/3-way valve can be found at the intersection of the grey column in step 1 and the row for the pneumatic drive DNC-50-... selected, in the table area "Proportional 5/3-way valve". In the case of our example, this is the proportional 5/3-way valve MPYE-5-1/8-HF-010B with the part number 151693.

Step 5: Complete the order information

To order a complete system you must add the order data for the end-position controller, valve and controller cables and manual (if required). The complete ordering data for the example described can be found → 19. A manual should normally be ordered. If you already have one, leave the appropriate box blank, indicating an express waiver of a manual.

Step 6: Determine the travel time

To determine the travel time, use the "Soft Stop" software tool. In the order example, the travel time is 0.96 seconds.

 - Note
Engineering software
Soft Stop and ProDrive
→ www.festo.com

 - Note
When selecting drive mounting components, please note that these are often not backlash-free and therefore cannot be used in conjunction with the Soft Stop system. The drives must be mounted directly.

 - Note
Check that the loads placed on the drive by the workpiece gripper during the movement process do not exceed permissible limits. To perform a simulation quickly and easily, use the Smart Soft Stop software tool.

 - Note
The self-aligning rod coupler FK is not backlash-free. It must not therefore be used in combination with standard cylinder DNC.

Ordering data							
Pneumatic drive		Linear potentiometer		Proportional 5/3-way valve		End-position controller	
Part No.	Type	Part No.	Type	Part No.	Type	Part No.	Type
163378	DNC-50-320-PPV-A	152647	MLO-POT-360-LWG	151693	MPYE-5-1/8-HF-010B	192217	SPC11-POT-LWG
Valve cable				Controller cable			
Part No.	Type	Part No.	Type	Part No.	Type	Part No.	Type
170238	KMPYE-AIF-1-GS-GD-2	177674	KMPV-SUB-D-15-10				

End-position controllers SPC11

Technical data

Step 1 and 2:											
Standard cylinders/Type		DNC-... ¹⁾ -... ²⁾ -PPV-A									
Max. cylinder working stroke	[mm]	100	150	150	225	225	300	360	450	600	750
Cylinder working stroke (standard stroke)	[mm]	80	100	125	160	200	250	320	400	500	650
Max. overall mass to be moved horizontally with \varnothing	32	45 kg									
	40	75 kg									
	50	120 kg									
	63	180 kg									
	80	300 kg									
Part No. for \varnothing	32	163308	163309	163310	163311	163312	163313	163314	163315	163316	163304
	40	163340	163341	163342	163343	163344	163345	163346	163347	163348	163336
	50	163372	163373	163374	163375	163376	163377	163378	163379	163380	163368
	63	163404	163405	163406	163407	163408	163409	163410	163411	163412	163400
	80	163436	163437	163438	163439	163440	163441	163442	163443	163444	163432

Step 3:											
Linear potentiometer ³⁾		MLO-POT-...-LWG									
Max. cylinder working stroke	[mm]	100	150	150	225	225	300	360	450	600	750
Potentiometer length	[mm]	100	150	150	225	225	300	360	450	600	750
Part No.		192213	192214	192214	152645	152645	152646	152647	152648	152650	152651

Step 4:											
Proportional 5/3-way valves ³⁾		1 = 151692 MPYE-5-1/8-LF-010					3 = 151694 MPYE-5-1/4-010-B				
Part No./Type		2 = 151693 MPYE-5-1/8-HF-010					4 = 151695 MPYE-5-3/8-010				
Max. cylinder working stroke	[mm]	100	150	150	225	225	300	360	450	600	750
Horizontally for \varnothing	32	1	1	1	1	1	1	1	1	2	2
	40	1	1	1	1	1	1	2	2	3	3
	50	1	1	1	1	1	1	2	2	3	3
	63	1	1	1	1	2	2	2	3	3	4
	80	1	1	2	2	3	3	3	3	4	4

Step 5:				
End-position controllers and accessories	Part No.	Type	Brief description	
End-position controller	192217	SPC11-POT-LWG		
Cable	Valve	170238	KMPYE-AIF-1-GS-GD-2	Cable length 2 m
		170239	KMPYE-AIF-1-GS-GD-0,3	Cable length 0,3 m
	SPC11/PLC	177673	KMPV-SUB-D-15-5	Cable length 5 m
		177674	KMPV-SUB-D-15-10	Cable length 10 m

 Note
Manuals → 31

- 1) Specify diameter. Technical data and dimensions → Internet: dnc
- 2) Specify cylinder working stroke determined.
- 3) Technical data and dimensions → Internet: mlo
- 4) Technical data and dimensions → Internet: mpye

End-position controllers SPC11

Technical data

FESTO

Accessories for solution package for horizontal mounting position with DNC

For cylinder working stroke 80 ... 750 mm

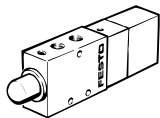
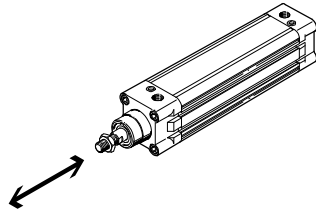

Ordering data									
Cylinder working stroke DNC [mm]	Proportional 5/3-way valve Type	Fittings ¹⁾				Tubing		Silencer ²⁾	
		For MPYE-5-...		For DNC		Part No.	Type	Part No.	Type
		Part No.	Type	Part No.	Type			Part No.	Type
Ø 32									
80 ... 440	MPYE-5-1/8-LF-010	153004	QS-1/8-8	153004	QS-1/8-8	152587	PUN-8x1,25	2307	U-1/8
441 ... 735	MPYE-5-1/8-HF-010								
Ø 40									
80 ... 290	MPYE-5-1/8-LF-010	153004	QS-1/8-8	153005	QS-1/4-8	152587	PUN-8x1,25	2307	U-1/8
291 ... 440	MPYE-5-1/8-HF-010			153005	QS-1/4-8				
441 ... 735	MPYE-5-1/4-010-B	153007	QS-1/4-10	153007	QS-1/4-10	152588	PUN-10x1,5	2316	U-1/4
Ø 50									
80 ... 290	MPYE-5-1/8-LF-010	153004	QS-1/8-8	153005	QS-1/4-8	152587	PUN-8x1,25	2307	U-1/8
291 ... 440	MPYE-5-1/8-HF-010								
441 ... 735	MPYE-5-1/4-010-B	153007	QS-1/4-10	153007	QS-1/4-10	152588	PUN-10x1,5	2316	U-1/4
Ø 63									
80 ... 175	MPYE-5-1/8-LF-010	153004	QS-1/8-8	153006	QS-3/8-8	152587	PUN-8x1,25	2307	U-1/8
176 ... 350	MPYE-5-1/8-HF-010			153006	QS-3/8-8				
351 ... 590	MPYE-5-1/4-010-B	153007	QS-1/4-10	153008	QS-3/8-10	152588	PUN-10x1,5	2316	U-1/4
591 ... 735	MPYE-5-3/8-010	153009	QS-3/8-12	153009	QS-3/8-12	152589	PUN-12x2	2309	U-3/8
Ø 80									
80 ... 115	MPYE-5-1/8-LF-010	153004	QS-1/8-8	153006	QS-3/8-8	152587	PUN-8x1,25	2307	U-1/8
116 ... 175	MPYE-5-1/8-HF-010			153006	QS-3/8-8				
176 ... 440	MPYE-5-1/4-010-B	153007	QS-1/4-10	153008	QS-3/8-10	152588	PUN-10x1,5	2316	U-1/4
441 ... 735	MPYE-5-3/8-010	153009	QS-3/8-12	153009	QS-3/8-12	152589	PUN-12x2	2309	U-3/8

1) Fittings are only supplied in batches of 10.

2) 2 of these are required.

End-position controllers SPC11

Technical data

FESTO

Accessories for solution package for horizontal mounting position with DNC

For cylinder working stroke 80 ... 750 mm

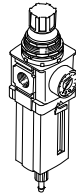
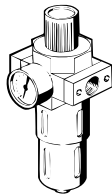

Ordering data								
Cylinder working stroke DNC [mm]	Filter regulator, D series with filter cartridge 5 mm		Filter cartridge 5 mm D series		Filter regulator, MS series with filter cartridge 5 mm		Filter cartridge 5 mm MS series	
	Part No.	Type	Part No.	Type	Part No.	Type	Part No.	Type
Ø 32								
80 ... 735	162719	LFR-1/4-D-5M-MINI	159640	LFP-D-MINI-5M	529152	MS4-LFR-1/4-D7-CRM-AS	534501	MS4-LFP-C
Ø 40								
80 ... 440	162719	LFR-1/4-D-5M-MINI	159640	LFP-D-MINI-5M	529152	MS4-LFR-1/4-D7-CRM-AS	534501	MS4-LFP-C
441 ... 735	162721	LFR-3/8-D-5M-MIDI	159594	LFP-D-MIDI-5M	529204	MS6-LFR-1/4-D7-CRM-AS	534499	MS6-LFP-C
Ø 50								
80 ... 440	162719	LFR-1/4-D-5M-MINI	159640	LFP-D-MINI-5M	529152	MS4-LFR-1/4-D7-CRM-AS	534501	MS4-LFP-C
441 ... 735	162721	LFR-3/8-D-5M-MIDI	159594	LFP-D-MIDI-5M	529204	MS6-LFR-1/4-D7-CRM-AS	534499	MS6-LFP-C
Ø 63								
80 ... 350	162719	LFR-1/4-D-5M-MINI	159640	LFP-D-MINI-5M	529152	MS4-LFR-1/4-D7-CRM-AS	534501	MS4-LFP-C
351 ... 590	162721	LFR-3/8-D-5M-MIDI	159594	LFP-D-MIDI-5M	529204	MS6-LFR-1/4-D7-CRM-AS	534499	MS6-LFP-C
591 ... 735	162724	LFR-3/4-D-5M-MAXI	159641	LFP-D-MAXI-5M	529224	MS6-LFR-3/8-D7-CRM-AS	534499	MS6-LFP-C
Ø 80								
80 ... 175	162719	LFR-1/4-D-5M-MINI	159640	LFP-D-MINI-5M	529152	MS4-LFR-1/4-D7-CRM-AS	534501	MS4-LFP-C
176 ... 440	162721	LFR-3/8-D-5M-MIDI	159594	LFP-D-MIDI-5M	529204	MS6-LFR-1/4-D7-CRM-AS	534499	MS6-LFP-C
441 ... 735	162724	LFR-3/4-D-5M-MAXI	159641	LFP-D-MAXI-5M	529224	MS6-LFR-3/8-D7-CRM-AS	534499	MS6-LFP-C

End-position controllers SPC11

Technical data

Order example for pneumatic standard drive DNCI with integrated displacement encoder

A workpiece weighing 55 kg must be conveyed horizontally on a loading station. The workpiece gripper

mounted on the piston rod of the drive weighs 40 kg. The total weight to be weighed is thus 95 kg. The distance to

be travelled is 300 mm. The travel time should be < 1.5 seconds.

Step 1: Determine the cylinder stroke

For a travel distance of 300 mm, the nearest standard stroke greater than this of 320 mm or the cylinder working stroke of 320 mm should be selected from the table → 23. This column has a grey background.

Step 2: Specify the drive

For the total mass of 95 kg to be moved horizontally, there is a choice of piston diameter of 50 or 63 mm (see in each case the maximum total mass to be moved).

For the example, the selected drive is a DNCI-50-320-P-A with part number 535413.

Step 3: Specify a proportional 5/3-way valve

The appropriate proportional 5/3-way valve can be found at the intersection of the grey column in step 1 and the row for the pneumatic drive DNCI-50-... selected, in the table area "Proportional 5/3-way valve". In the case of our example, this is the proportional 5/3-way valve MPYE-5-1/8-HF-010B with the part number 151693.

Step 4: Complete the order information

To order a complete system you must add the order data for the end-position controller, valve and controller cables and manual (if required). The complete ordering data for the example described can be found → 23. A manual should normally be ordered. If you already have one, leave the appropriate box blank, indicating an express waiver of a manual.

Step 5: Determine the travel time

To determine the travel time, use the "Soft Stop" software tool. In the order example, the travel time is 0.92 seconds.

-  - Note

Engineering software
Soft Stop and ProDrive
→ www.festo.com

-  - Note

When selecting drive mounting components, please note that these are often not backlash-free and therefore cannot be used in conjunction with the Soft Stop system. The drives must be mounted directly.

-  - Note

Check that the loads placed on the drive by the workpiece gripper during the movement process do not exceed permissible limits.

To carry out simulation quickly and easily, use the Smart Soft Stop software tool.

-  - Note

The self-aligning rod coupler FK is not backlash-free. It must not therefore be used in combination with standard cylinder DNCI.

Ordering data					
Pneumatic drive		Proportional 5/3-way valve		End-position controller	
Part No.	Type	Part No.	Type	Part No.	Type
535413	DNCI-50-320-P-A	151693	MPYE-5-1/8-HF-010B	537321	SPC11-INC

Valve cable		Controller cable	
Part No.	Type	Part No.	Type
170238	KMPYE-AIF-1-GS-GD-2	177674	KMPV-SUB-D-15-10

End-position controllers SPC11

Technical data

Step 1 and 2:									
Standard cylinders/Type		DNCl-... ¹⁾ -... ²⁾ -P-A							
Cylinder working stroke (standard stroke)	[mm]	100	160	200	250	320	400	500	
	Max. overall mass to be moved horizontally with Ø	32	45 kg						
		40	75 kg						
		50	120 kg						
	63	180 kg							
Part No. for Ø	32	535411							
	40	535412							
	50	535413							
	63	535414							

Step 3:								
Proportional 5/3-way valves ³⁾		1 = 151692 MPYE-5-1/8-LF-010			3 = 151694 MPYE-5-1/4-010-B			
Part No./Type		2 = 151693 MPYE-5-1/8-HF-010						
Cylinder working stroke (standard stroke)	[mm]	100	160	200	250	320	400	500
	Horizontally for Ø	32	1	1	1	1	1	2
		40	1	1	1	2	2	2
		50	1	1	1	2	2	3
	63	1	1	2	2	2	3	

Step 4:				
End-position controllers and accessories		Part No.	Type	Brief description
End-position controller	SPC11	537321	SPC11-INC	
Cable	Valve	170238	KMPYE-AIF-1-GS-GD-2	Cable length 2 m
		170239	KMPYE-AIF-1-GS-GD-0,3	Cable length 0.3 m
	SPC11/PLC	177673	KMPV-SUB-D-15-5	Cable length 5 m
		177674	KMPV-SUB-D-15-10	Cable length 10 m

 Note
Manuals → 31

- 1) Specify diameter. Technical data and dimensions → Internet: dnci
- 2) Specify cylinder working stroke determined.
- 3) Technical data and dimensions → mpye

End-position controllers SPC11

Technical data



Accessories for solution package for horizontal mounting position with DNCI

For cylinder working stroke 100 ... 500 mm

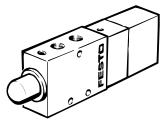
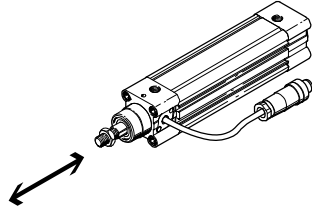

Ordering data									
Cylinder working stroke DNCI [mm]	Proportional 5/3-way valve Type	Fittings ¹⁾				Tubing		Silencer ²⁾	
		For MPYE-5-...		For DNCI		Part No.	Type	Part No.	Type
		Part No.	Type	Part No.	Type				
Ø 32									
100 ... 400	MPYE-5-1/8-LF-010	153004	QS-1/8-8	153004	QS-1/8-8	152587	PUN-8x1,25	2307	U-1/8
500	MPYE-5-1/8-HF-010								
Ø 40									
100 ... 250	MPYE-5-1/8-LF-010	153004	QS-1/8-8	153005	QS-1/4-8	152587	PUN-8x1,25	2307	U-1/8
320 ... 500	MPYE-5-1/8-HF-010								
Ø 50									
100 ... 250	MPYE-5-1/8-LF-010	153004	QS-1/8-8	153005	QS-1/4-8	152587	PUN-8x1,25	2307	U-1/8
320 ... 400	MPYE-5-1/8-HF-010								
500	MPYE-5-1/4-010-B	153007	QS-1/4-10	153007	QS-1/4-10	152588	PUN-10x1,5	2316	U-1/4
Ø 63									
100 ... 160	MPYE-5-1/8-LF-010	153004	QS-1/8-8	153006	QS-3/8-8	152587	PUN-8x1,25	2307	U-1/8
200 ... 320	MPYE-5-1/8-HF-010								
400 ... 500	MPYE-5-1/4-010-B	153007	QS-1/4-10	153008	QS-3/8-10	152588	PUN-10x1,5	2316	U-1/4

1) Fittings are only supplied in batches of 10.

2) 2 of these are required.

End-position controllers SPC11

Technical data

FESTO

Accessories for solution package for horizontal mounting position with DNCI

For cylinder working stroke 100 ... 500 mm

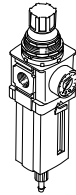
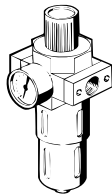

Ordering data								
Cylinder working stroke DNCI [mm]	Filter regulator, D series with filter cartridge 5 mm		Filter cartridge 5 mm D series		Filter regulator, MS series with filter cartridge 5 mm		Filter cartridge 5 mm MS series	
	Part No.	Type	Part No.	Type	Part No.	Type	Part No.	Type
Ø 32								
100 ... 500	162719	LFR-¼-D-5M-MINI	159640	LFP-D-MINI-5M	529152	MS4-LFR-¼-D7-CRM-AS	534501	MS4-LFP-C
Ø 40								
100 ... 400	162719	LFR-¼-D-5M-MINI	159640	LFP-D-MINI-5M	529152	MS4-LFR-¼-D7-CRM-AS	534501	MS4-LFP-C
500	162721	LFR-¾-D-5M-MIDI	159594	LFP-D-MIDI-5M	529204	MS6-LFR-¼-D7-CRM-AS	534499	MS6-LFP-C
Ø 50								
100 ... 400	162719	LFR-¼-D-5M-MINI	159640	LFP-D-MINI-5M	529152	MS4-LFR-¼-D7-CRM-AS	534501	MS4-LFP-C
500	162721	LFR-¾-D-5M-MIDI	159594	LFP-D-MIDI-5M	529204	MS6-LFR-¼-D7-CRM-AS	534499	MS6-LFP-C
Ø 63								
100 ... 320	162719	LFR-¼-D-5M-MINI	159640	LFP-D-MINI-5M	529152	MS4-LFR-¼-D7-CRM-AS	534501	MS4-LFP-C
400 ... 500	162721	LFR-¾-D-5M-MIDI	159594	LFP-D-MIDI-5M	529204	MS6-LFR-¼-D7-CRM-AS	534499	MS6-LFP-C

End-position controllers SPC11

Technical data

Order example for semi-rotary drive DSMI

A workpiece with a mass moment of inertia of $400 \text{ kgm}^2 \times 10^{-4}$ needs to be conveyed on an unloading station. The workpiece gripper mounted on the

shaft of the semi-rotary drive has a mass moment of inertia of $230 \text{ kgm}^2 \times 10^{-4}$. The total mass moment of inertia to be moved is thus

$630 \text{ kgm}^2 \times 10^{-4}$. The swivel angle is 250° . The travel time should be < 1 second.

Step 1: Specify the swivel angle

The maximum swivel angle of the semi-rotary drive DSMI-25-270, DSMI-40-270 and DSMI-63-270 is in each case 270° , and can be used in its entirety. The integrated displacement encoder is appropriately designed.

Step 4: Complete the order information

To order a complete system you must add the order data for the end-position controller, valve and controller cables and manual (if required). The complete ordering data for the example described can be found → 27. A manual should normally be ordered. If you already have one, leave the appropriate box blank, indicating that you do not want a manual.

Step 2: Specify the drive

For the total mass moment of inertia of $630 \text{ kgm}^2 \times 10^{-4}$ to be moved horizontally, it is necessary to use the DSMI-40-270 → 27.

Step 5: Determine the travel time

To determine the travel time, use the "Soft Stop" software tool. In the order example, the travel time is 0.89 seconds.

Step 3: Specify a proportional 5/3-way valve

As can be seen from the table → 27, in general the semi-rotary drive DSMI-40-270 requires the proportional 5/3-way valve MPYE-5-1/8-LF-010B

 - Note

Engineering software
Soft Stop and ProDrive
→ www.festo.com

 - Note

When selecting drive mounting components, please note that these are often not backlash-free and therefore cannot be used in conjunction with the Soft Stop system. The drives must be mounted directly.

 - Note

Check that the loads placed on the drive by the workpiece gripper during the movement process do not exceed permissible limits. To perform a simulation quickly and easily, use the Smart Soft Stop software tool.

Ordering data					
Semi-rotary drive		Proportional 5/3-way valve		End-position controller	
Part No.	Type	Part No.	Type	Part No.	Type
561691	DSMI-40-270-A-B	151692	MPYE-5-1/8-LF-010B	192217	SPC11-POT-LWG
Valve cable			Controller cable		
Part No.	Type	Part No.	Type	Part No.	Type
170238	KMPYE-AIF-1-GS-GD-2	177674	KMPV-SUB-D-15-10		

End-position controllers SPC11

Technical data

Step 1 and 2:			
Semi-rotary drive with integrated potentiometer	DSMI-25-270-A-B	DSMI-40-270-A-B	DSMI-63-270-A-B
Swivel angle	270°		
Max. permissible mass moment of inertia, horizontal	300 kgm ² x10 ⁻⁴	1200 kgm ² x10 ⁻⁴	6000 kgm ² x10 ⁻⁴
Part No.	561690	561691	1202485

Step 3:						
Proportional 5/3-way valves ¹⁾	Part No.	Type	Part No.	Type	Part No.	Type
	154200	MPYE-5-M5-010B	151692	MPYE-5-1/8-LF-010B	151692	MPYE-5-1/8-LF-010B

Step 4:				
End-position controllers and accessories	Part No.	Type	Brief description	
End-position controller SPC11	192217	SPC11-POT-LWG		
Cable	170238	KMPYE-AIF-1-GS-GD-2	Cable length 2 m	
	170239	KMPYE-AIF-1-GS-GD-0,3	Cable length 0.3 m	
	SPC11/PLC	177673	KMPV-SUB-D-15-5	Cable length 5 m
		177674	KMPV-SUB-D-15-10	Cable length 10 m

 Note
 Manuals → 31

1) Technical data and dimensions → Internet: dsmi

End-position controllers SPC11

Technical data

FESTO

Accessories for solution package for horizontal mounting position with DSMI

For swivel angle 0° ... 270°

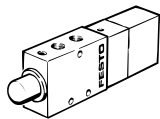
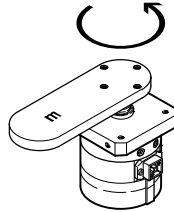

Ordering data									
Swivel angle	Proportional	Fittings ¹⁾				Tubing		Silencer ²⁾	
DSMI	5/3-way valve	For MPYE-5-...		For DSMI					
	Type	Part No.	Type	Part No.	Type	Part No.	Type	Part No.	Type
Size 25									
0° ... 270°	MPYE-5-M5-010-B	153306	QSM-M5-6	153306	QSM-M5-6	152586	PUN-6x1	1205858	AMTE-M-LH-M5
Size 40									
0° ... 270°	MPYE-5-1/8-LF-010-B	153004	QS-1/8-8	153004	QS-1/8-8	152587	PUN-8x1,25	2307	U-1/8
Size 63									
0° ... 270°	MPYE-5-1/8-LF-010-B	153004	QS-1/8-8	153005	QS-1/4-8	152587	PUN-8x1,25	2307	U-1/8

1) Fittings are only supplied in batches of 10.

2) 2 of these are required.

End-position controllers SPC11

Technical data



Accessories for solution package for horizontal mounting position with DSMI

For swivel angle 0° ... 270°

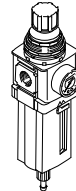
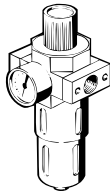

Ordering data								
Swivel angle	Filter regulator, D series with filter cartridge 5 µm		Filter cartridge 5 µm D series		Filter regulator, MS series with filter cartridge 5 µm		Filter cartridge 5 µm MS series	
DSMI	Part No.	Type	Part No.	Type	Part No.	Type	Part No.	Type
Size 25								
0° ... 270°	162719	LFR-¼-D-5M-MINI	159640	LFP-D-MINI-5M	529152	MS4-LFR-¼-D7-CRM-AS	534501	MS4-LFP-C
Size 40								
0° ... 270°	162719	LFR-¼-D-5M-MINI	159640	LFP-D-MINI-5M	529152	MS4-LFR-¼-D7-CRM-AS	534501	MS4-LFP-C
Size 63								
0° ... 270°	162719	LFR-¼-D-5M-MINI	159640	LFP-D-MINI-5M	529152	MS4-LFR-¼-D7-CRM-AS	534501	MS4-LFP-C

End-position controllers SPC11

Technical data

Mass moment of inertia calculation with the aid of Festo software

Software tool: mass moment of inertia

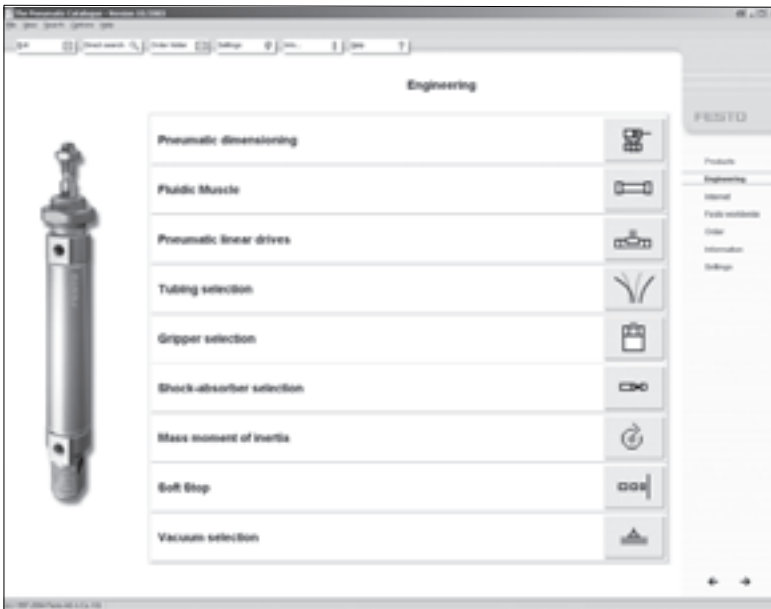

Whether washers, blocks, push-on flanges or grippers, this tool does the job of calculating all mass moments of inertia for you. Just save, send, or print – and you're finished.

 - Note
 Configuration software for calculating the mass moment of inertia
[→ www.festo.com](http://www.festo.com)

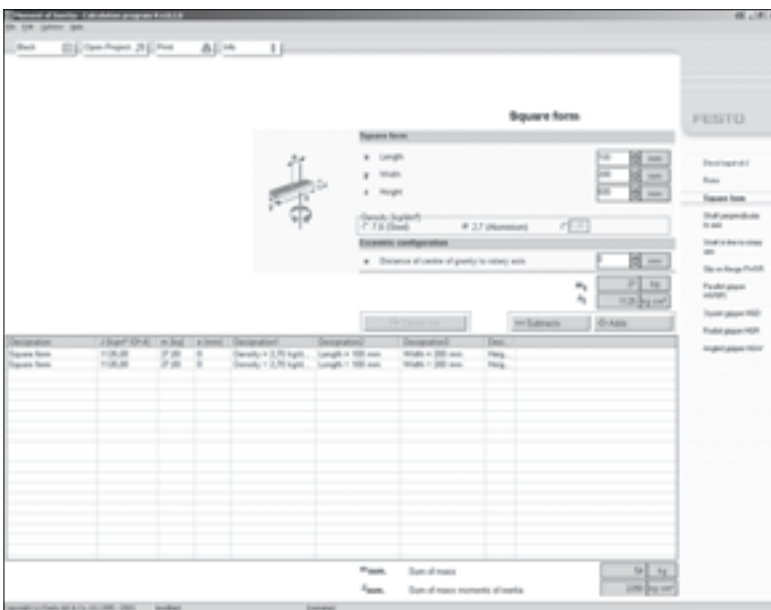

End-position controllers SPC11

Technical data



Ordering data – Manuals							
		Part No.	Type		Part No.	Type	
System description – End-position controllers							
SPC11	German	196723	P.BE-SPC11-SYS-DE				
	English	196724	P.BE-SPC11-SYS-EN				
	French	196727	P.BE-SPC11-SYS-FR				
	Italian	196726	P.BE-SPC11-SYS-IT				
	Spanish	196725	P.BE-SPC11-SYS-ES				
Drive-specific supplement							
For DGCI/DDLI				For DSMI			
SPC11	German	549166	P.BE-SPC11-DGCI-DE	SPC11	German	196741	P.BE-SPC11-DSMI-DE
	English	549167	P.BE-SPC11-DGCI-EN		English	196742	P.BE-SPC11-DSMI-EN
	French	549169	P.BE-SPC11-DGCI-FR		French	196745	P.BE-SPC11-DSMI-FR
	Italian	549170	P.BE-SPC11-DGCI-IT		Italian	196744	P.BE-SPC11-DSMI-IT
	Spanish	549168	P.BE-SPC11-DGCI-ES		Spanish	196743	P.BE-SPC11-DSMI-ES
For DNC				For DNCI			
SPC11	German	196735	P.BE-SPC11-DNC-DE	SPC11	German	539888	P.BE-SPC11-DNCI-DE
	English	196736	P.BE-SPC11-DNC-EN		English	539889	P.BE-SPC11-DNCI-EN
	French	196739	P.BE-SPC11-DNC-FR		French	539891	P.BE-SPC11-DNCI-FR
	Italian	196738	P.BE-SPC11-DNC-IT		Italian	539892	P.BE-SPC11-DNCI-IT
	Spanish	196737	P.BE-SPC11-DNC-ES		Spanish	539890	P.BE-SPC11-DNCI-ES

End-position controllers SPC11

Technical data



Converting existing systems

What should be taken into consideration when converting existing systems that use pneumatic drive DGC or DNC?	Optimum system behaviour is guaranteed by Festo's uniquely specified solution packages, in which all	components are harmonised. When converting existing systems, observe the following points:	
Where could system behaviour possibly change when an existing system is converted?	In normal cases, the entire cylinder stroke is used, including the internal	cushioning length (PPV); no stroke reserve is available.	
What should be noted when installing the pneumatics?	<ul style="list-style-type: none"> Pay particular attention here to symmetrical arrangement, i.e. ensure that the tube length is equal for compressed air supply to the drive on both sides. 	<ul style="list-style-type: none"> No flow control valves between the valve and drive. Open end-position cushioning (PPV) 100%. 	Accessories and tubing diameters can be found in the description for the respective solution package.
What should be noted when installing the electrics?	As far as the electrical actuation is concerned, the Smart Soft Stop system behaves like a standard pneu-	matic system which uses a double solenoid valve with two coils and two proximity sensors.	For further information see the manual System description: SPC11-... → 31.
Does the control program need to be adapted?	Existing systems which have provision for two digital inputs/outputs can be	converted without adaptation of the control program.	
What proportional 5/3-way valve should be selected for the conversion project?	There is no change compared to the solution package → 19.		

What end-position controller is suitable for each drive or displacement encoder?

End-position controller	Drive	Displacement encoder
SPC11-POT-TLF	DGC-KF	MLO-POT-...-TLF
SPC11-POT-LWG	DNC	MLO-POT-...-LWG
	DSMI	Integrated
SPC11-MTS-AIF	DGC-KP	MME-MTS-...-AIF
SPC11-INC	DNCI	Integrated
SPC11-MTS-AIF-2	DGCI/DDLI	Adapted

Product Range and Company Overview

A Complete Suite and Company Overview

Our experienced engineers provide complete support at every stage of your development process, including: conceptualization, analysis, engineering, design, assembly, documentation, validation, and production.



Custom Automation Components
Complete custom engineered solutions



Custom Control Cabinets
Comprehensive engineering support and on-site services



Complete Systems
Shipment, stocking and storage services

The Broadest Range of Automation Components

With a comprehensive line of more than 30,000 automation components, Festo is capable of solving the most complex automation requirements.



Electromechanical
Electromechanical actuators, motors, controllers & drivers



Pneumatics
Pneumatic linear and rotary actuators, valves, and air supply



PLCs and I/O Devices
PLC's, operator interfaces, sensors and I/O devices

Supporting Advanced Automation... As No One Else Can!

Festo is a leading global manufacturer of pneumatic and electromechanical systems, components and controls for industrial automation, with more than 16,000 employees in 60 national headquarters serving more than 180 countries. For more than 80 years, Festo has continuously elevated the state of manufacturing with innovations and optimized motion control solutions that deliver higher performing, more profitable automated manufacturing and processing equipment. Our dedication to the advancement of automation extends beyond technology to the education and development of current and future automation and robotics designers with simulation tools, teaching programs, and on-site services.

Quality Assurance, ISO 9001 and ISO 14001 Certifications

Festo Corporation is committed to supply all Festo products and services that will meet or exceed our customers' requirements in product quality, delivery, customer service and satisfaction.

To meet this commitment, we strive to ensure a consistent, integrated, and systematic approach to management that will meet or exceed the requirements of the ISO 9001 standard for Quality Management and the ISO 14001 standard for Environmental Management.



© Copyright 2013, Festo Corporation. While every effort is made to ensure that all dimensions and specifications are correct, Festo cannot guarantee that publications are completely free of any error, in particular typing or printing errors. Accordingly, Festo cannot be held responsible for the same. For Liability and Warranty conditions, refer to our "Terms and Conditions of Sale", available from your local Festo office. All rights reserved. No part of this publication may be reproduced, distributed, or transmitted in any form or by any means, electronic, mechanical, photocopying or otherwise, without the prior written permission of Festo. All technical data subject to change according to technical update.



Printed on recycled paper at New Horizon Graphic, Inc., FSC certified as an environmental friendly printing plant.

Festo North America

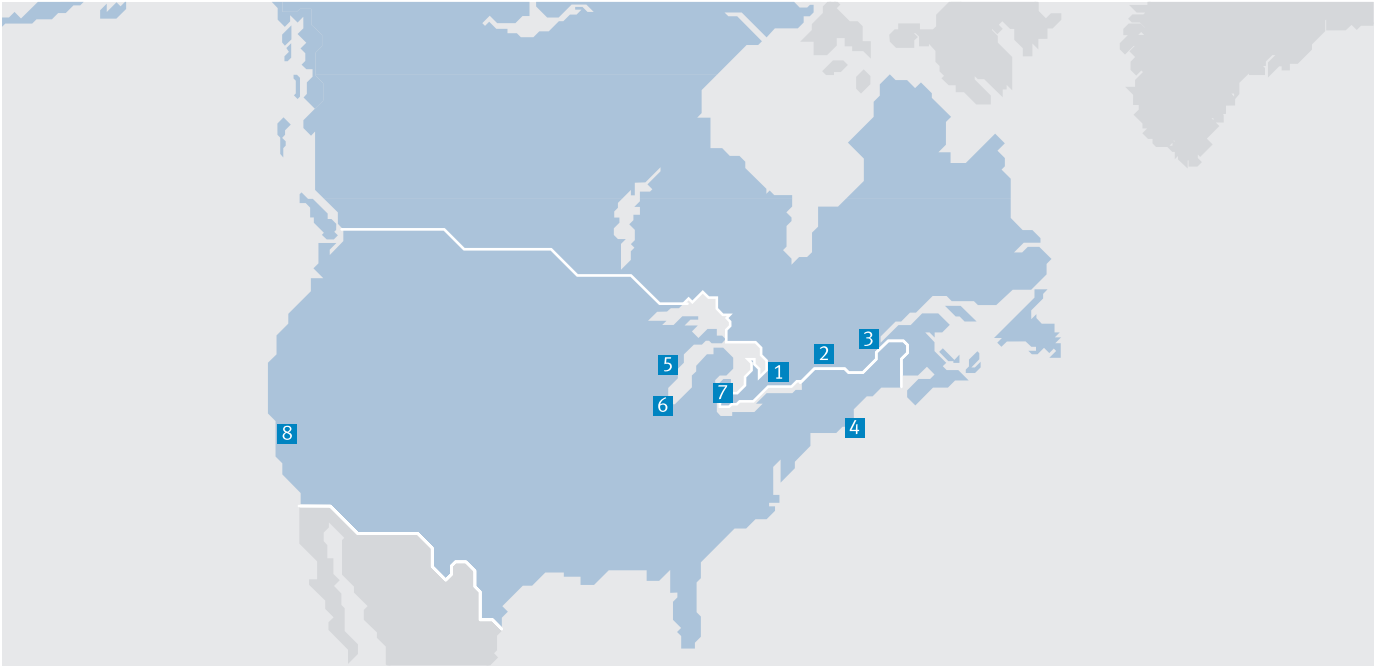

**1 Festo Canada
Headquarters
Festo Inc.**
5300 Explorer Drive
Mississauga, ON
L4W 5G4

2 Montréal
5600, Trans-Canada
Pointe-Claire, QC
H9R 1B6

3 Québec City
2930, rue Watt#117
Québec, QC
G1X 4G3



**4 Festo United States
Headquarters
Festo Corporation**
395 Moreland Road
Hauppauge, NY
11788

5 Appleton
North 922 Tower View Drive, Suite N
Greenville, WI
54942

7 Detroit
1441 West Long Lake Road
Troy, MI
48098

6 Chicago
85 W Algonquin - Suite 340
Arlington Heights, IL
60005

8 Silicon Valley
4935 Southfront Road, Suite F
Livermore, CA
94550

Festo Regional Contact Center

Canadian Customers

Commercial Support:
Tel: 1 877 GO FESTO (1 877 463 3786)
Fax: 1 877 FX FESTO (1 877 393 3786)
Email: festo.canada@ca.festo.com

Technical Support:
Tel: 1 866 GO FESTO (1 866 463 3786)
Fax: 1 877 FX FESTO (1 877 393 3786)
Email: technical.support@ca.festo.com

USA Customers

Commercial Support:
Tel: 1 800 99 FESTO (1 800 993 3786)
Fax: 1 800 96 FESTO (1 800 963 3786)
Email: customer.service@us.festo.com

Technical Support:
Tel: 1 866 GO FESTO (1 866 463 3786)
Fax: 1 800 96 FESTO (1 800 963 3786)
Email: product.support@us.festo.com