

Motion Terminal VTEM



Festo core product range
Covers 80% of your automation tasks

Worldwide:

Always in stock

Superb:

Festo quality at an attractive price

Easy:

Reduces procurement and storing complexity

★ Ready for dispatch from the Festo factory in 24 hours
Held in stock in 13 service centres worldwide
More than 2200 products

★ Ready for dispatch in 5 days maximum from stock
Assembled for you in 4 service centres worldwide
Up to 6×10^{12} variants per product series

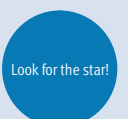

Motion Terminal VTEM

Key features

Innovative

Benefits of piezo valves for pilot control:

- Pressure regulation function
- Maximum service life
- Minimum energy requirement
- Low leakage when acting as a proportional pressure regulator

Integrated controller permits:

- Cyclical changes to the valve function
- Function integration via Motion Apps

Versatile

The valves are connected to form a full bridge within the valve body, enabling a wide range of directional control valve functions to be realised at one valve position.

These functions are assigned to the valve by the connected controller and can be changed during operation. The pressure regulator functionality of the valves in combination with the integrated pilot control enables the Motion Terminal VTEM to autonomously perform precision positioning tasks.

Reliable

Integrated sensors monitor the switching status of the valves and the pressure in duct 1, 3, 2 and 4. Optional input modules enable the connected actuators to be monitored. This information is evaluated in the Motion Terminal VTEM itself and also transferred to a higher-order controller.

Easy to install

- No need to change the valve, as the directional control valve function is assigned using software
- Less storage space required: one valve for all functions
- Integrated mounting points for wall and H-rail mounting
- Integrated flow control functionality, no manual adjustment required
- Functions of 50 individual components integrated via Motion Apps

Ordering data – Product options

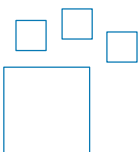

Configurable product
This product and all its product options can be ordered using the configurator.

The configurator can be found under Products on the DVD or
→ www.festo.com/catalogue/...

Part no. 8047502 Type code VTEM

Motion Terminal VTEM

Key features

Flexibility

Motion Apps

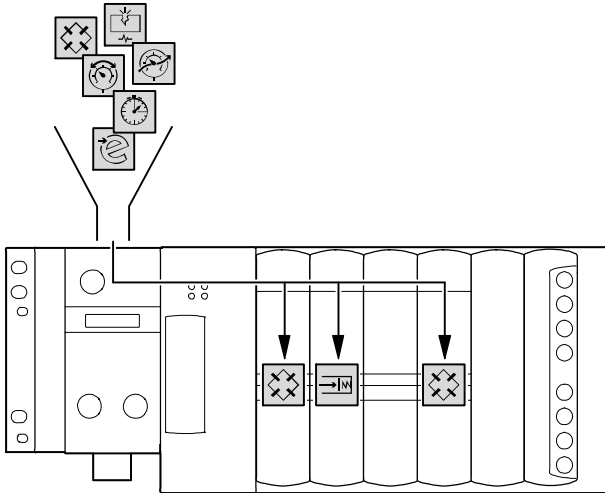

The valves of the Motion Terminal VTEM comprise four 2/2-way valves with piezo pilot control connected to form a full bridge, monitored by sensors.

This results in a series of special features compared with a valve terminal having conventional piston slide valves.

Depending on activation, the valves can perform the valve functions of:

- 2x 2/2-way valve
- 2x 3/2-way valve
- 4/2-way valve
- 4/3-way valve
- Proportional pressure regulator
- Proportional directional control valve

Functions usually associated with separate components, such as flow control or pressure regulation, can also be performed by the valves. Manual adjustment processes, procurement and maintenance are no longer needed as; all tasks are assigned and controlled centrally by means of software.

Which function a valve assumes and which tasks the controller can fulfil is determined by Motion Apps.

Licence packages

Each Motion Terminal VTEM is assigned a package of Motion App licences. This can be extended at any time; however, it is not possible to transfer licences from one Motion Terminal VTEM to another.

The valve functions that are available within the Motion Terminal can be freely assigned to each individual valve wherever and whenever necessary.

With the integrated sensors all valve functions can be comprehensively monitored.

The controller of the Motion Terminal can use this information to perform more complex pressure regulating tasks or switching of connected actuators.

Basic package



Directional control valve functions.

The Basic package is included with every Motion Terminal.

The Motion App “Directional control valve functions” can be used at the same time on all valve positions of the Motion Terminal.

Start package

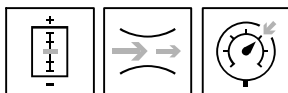

- Proportional directional control valve
- Supply and exhaust air flow control
- Selectable pressure level

The Start package can be ordered as an individual package for the Motion Terminal.

All Motion Apps in the Start package can be used at the same time on all valve positions of the Motion Terminal.

Additional apps

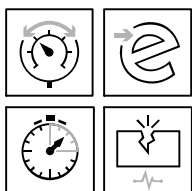

- Proportional pressure regulation
- ECO drive
- Presetting of travel time
- Leakage diagnostics

As well as the Basic and Start packages, other Motion Apps can be ordered individually for the Motion Terminal.

Depending on the Motion App, these can be used at the same time on all valve positions of the Motion Terminal, or must be ordered in the number required for simultaneous use on the Motion Terminal.

Motion Terminal VTEM

Key features

Integrated sensors

Monitoring functions

Integrated sensors monitor:

- Degree of opening of the valve (flow rate for supply air and exhaust air)
- Pressure

Monitoring is performed:

- For each individual valve
- For each individual valve connection

This produces the following diagnostic information:

- System leakage

Controlled movement

The ability to adapt pressure and flow rate, in combination with the integrated sensors, makes it possible to influence the cylinder movement directly.

This means that a wide range of requirements can be met:

- Independent, proportional regulation of the supply and exhaust air for each cylinder chamber

- Soft start
- Fast start
- Noise reduction
- Reduced vibrations

- No need for exhaust air flow control valves
- No need for shock absorbers

Energy efficiency

Energy-saving movement

Pressure at duct 2

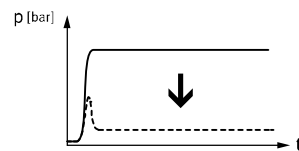

Movement with reduced force

Advantages:

- High energy efficiency, particularly energy-saving return stroke
- Reduced number of components

Objective:

Reduction in total costs thanks to motion control using less compressed air than when the drive is fully pressurised. This reduces operating costs and improves overall economic efficiency.

Principle:

Pressure is built up on the pressurisation side purely to create the differential pressure required to maintain movement (pre-exhausted). This means that less compressed air is needed for each cycle.

When the movement ends, the Motion Terminal VTEM closes the valve so that only the minimum static pressure sufficient to hold the cylinder in position is applied. The sensor monitoring means that, if there is a drop, the position is readjusted automatically

Application:

- Typically for fast running production machines (e.g. packaging, assembly or processing machines)
- Linear or rotary movement with a medium-sized stroke and/or high number of cycles

Pressure at duct 4

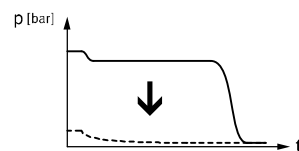

Piezo technology

The Motion Terminal VTEM uses piezo technology, which is characterised by low energy consumption.

Advantages:

- Low-energy power supply unit
- Small cable diameters
- Minimal self-heating

The degree of opening of the piezo valves can be freely controlled. This makes it possible to control the rate of flow through the valve:

- Without additional components
- Time-controlled
- Controlled by sensors
- For each individual valve
- For each individual valve connection

Control of the degree of opening together with the pressure sensors integrated in the Motion Terminal make it possible to adjust the pressure individually:

- For each individual cylinder chamber
- For each individual valve
- For each individual valve connection



Advantages:

- Lower air consumption owing to partial pressurisation
- Variable contact pressure in the end position or when clamping a workpiece
- Variable independent pressure for forward/return stroke

Motion Terminal VTEM



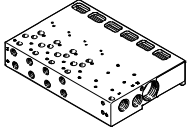
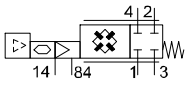
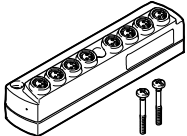



Product range overview

FESTO

Function	Version	Type code	Description	→ Page
Pneumatic/ mechanical	Pneumatic linkage			
		Fixed grid	VTEM	<ul style="list-style-type: none"> • 4 or 8 valve positions • 0 or 2 positions for input modules • With electrical interface for terminal CPX • Supply/exhaust ports and working ports for the mounted valves • Pilot air supply for the mounted valves • Electrical actuation for the mounted valves
	Valve			
		4x 2/2-way valve	VEVM	<ul style="list-style-type: none"> • Position if the power supply/signalling fails – all ducts closed • Connected in series to form a full bridge • Proportional pilot control by piezo valves • Degree of valve opening monitored by sensor • Pressure sensors in ports 2 and 4
Electronics	Input module			
		Analogue	CTMM-A	<ul style="list-style-type: none"> • 8 analogue inputs • M8, 4-pin • Exclusively for controlling the functions provided via the Motion Apps • Data can be transferred to a higher-order controller by the Motion Apps
Digital		CTMM-D	<ul style="list-style-type: none"> • 8 digital inputs • M8, 3-pin • Exclusively for controlling the functions provided via the Motion Apps • Data can be transferred to a higher-order controller by the Motion Apps 	20
Motion Apps	Basic package			
		Directional control valve functions	–	Valve type and switching status can be cyclically assigned to a valve: <ul style="list-style-type: none"> • 2x 2/2-way valve, normally closed • 2x 3/2-way valve, normally open • 2x 3/2-way valve, normally closed • 2x3/2-way valve, 1x normally closed, 1x normally open • 4/2-way valve, single solenoid • 4/2-way valve, double solenoid • 4/3-way valve, normally pressurised • 4/3-way valve, normally closed • 4/3-way valve, normally exhausted
The Motion Apps in the Basic package can be used at the same time on all valve positions of the Motion Terminal.				

Motion Terminal VTEM

Product range overview

Function	Version	Type code	Description	→ Page	
Motion Apps	Start package				
		Proportional directional control valve	STP	Valve type, switching status and a continuous valve opening can be cyclically assigned to a valve: <ul style="list-style-type: none"> • 4/3-way valve, normally closed • 2x 3/3-way valve, normally closed 	25
		Supply and exhaust air flow control	STP	Flow control function: <ul style="list-style-type: none"> • Supply air flow control • Exhaust air flow control • Comprises 4/4-way valve (corresponding to valve plus flow control) 	27
		Selectable pressure level	STP	Energy-saving cylinder movement using a reduced pressure level: <ul style="list-style-type: none"> • Pressure regulation for supply air • Flow control function for exhaust air 	30
	All Motion Apps in the Start package can be used at the same time on all valve positions of the Motion Terminal.				
	Additional apps				
		Proportional pressure regulation	PD	Regulation of the two valve outlet pressures independently of one another: <ul style="list-style-type: none"> • 2x proportional pressure regulator 	26
		ECO drive	STP	For applications with low loads or slow travel movement: <ul style="list-style-type: none"> • Energy-saving cylinder movement through supply air flow control • Adjustable supply-air flow control value • Blocks the supply air on reaching the end position • Sensors and digital input module required 	28
		Presetting of travel time	STP	Presetting the travel time for retracting and advancing: <ul style="list-style-type: none"> • Pre-calculation of the travel profile using set parameters • Teaching the system • Automatic readjustment of the system • Sensors and digital input module required 	29
		Leakage diagnostics	DLP	Air consumption monitoring: <ul style="list-style-type: none"> • Teaching the system • Diagnostic message using specified parameters 	31

Motion Terminal VTEM

Peripherals overview

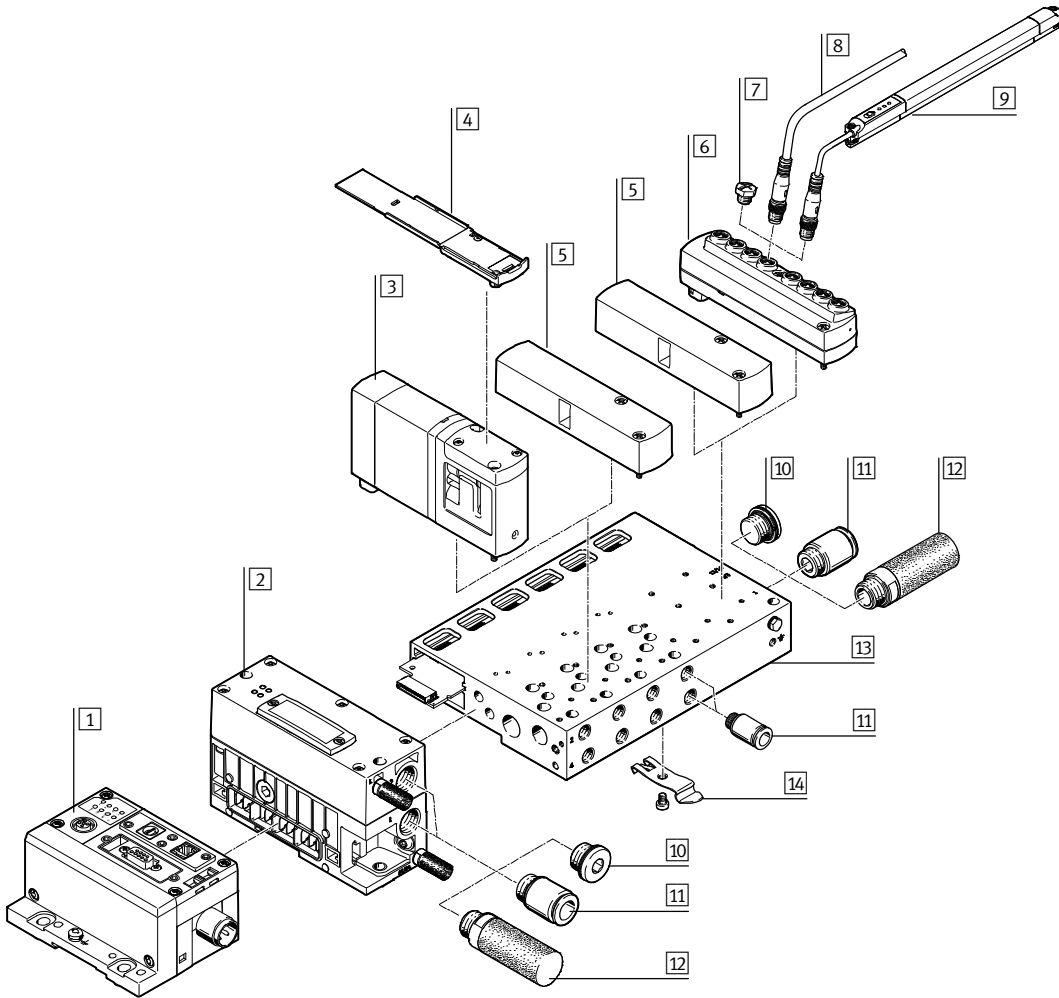

Designation	Brief description	→ Page/Internet
1 CPX modules	CPX Bus node, control block, input and output modules	cpx
2 Controller	CTMM For VTEM and pneumatic interface to the terminal CPX	14
3 Valve body	VEVM Contains 4 interconnected piston poppet valves with piezo pilot control	18
4 Identification holder	ASCF For a valve	32
5 Cover plate	VABB For unoccupied valve position (vacant position) or input module position	32
6 Input module	CTMM For connecting sensors to the VTEM	20
7 Cover cap	ISK For sealing unused ports	32
8 Connecting cable	NEBU For connecting sensors	33
9 Position sensor	SDAP Analogue position sensor for VTEM input module CTMM	32
10 Blanking plug	B For sealing unused ports	34
11 Fittings	QS For connecting compressed air tubing	33
12 Silencers	U For exhaust ports	34
13 Manifold rail	VABM Pneumatic and electrical linkage	32
14 H-rail mounting	VAME For CPX and VTEM	32

Motion Terminal VTEM

Peripherals overview

Connection of the Motion Terminal VTEM to a higher-level controller

Overview

CPX bus node/control block

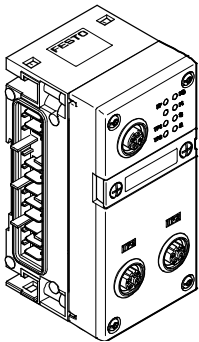
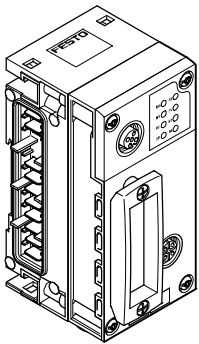
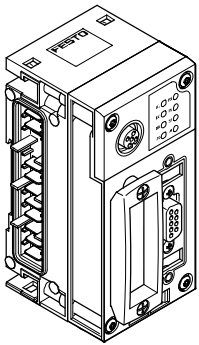
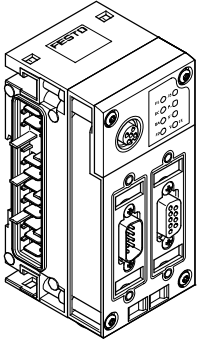

VTEM controller

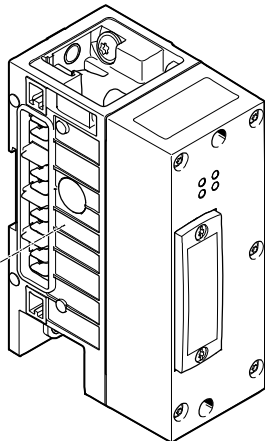

The precise technical data and specifications for CPS can be found online under:

→ Internet: cpx

Bus protocol/bus node

CODESYS

CPX-CEC-C1-V3
CPX-CEC-S1-V3
CPX-CEC-M1-V3

Special features

- Programming with CODESYS
- Ethernet interface
- Modbus/TCP
- EasyIP
- CANopen master
- Up to 512 digital inputs/outputs
- 32 analogue inputs
- 18 analogue outputs

PROFIBUS DP

CPX-FB13

- Up to 512 digital inputs/outputs
- 32 analogue inputs
- 18 analogue outputs

EtherNet/IP

CPX-FB36

- Up to 512 digital inputs/outputs
- 32 analogue inputs
- 18 analogue outputs

PROFINET

CPX-FB33
CPX-M-FB34

- Up to 512 digital inputs/outputs
- 32 analogue inputs
- 18 analogue outputs

EtherCAT®

CPX-FB37

- Up to 512 digital inputs/outputs
- 32 analogue inputs
- 18 analogue outputs

Motion Terminal VTEM

Characteristics – Pneumatics

Pneumatics of the Motion Terminal

The Motion Terminal VTEM is operated exclusively with the electric terminal CPX. A Motion Terminal VTEM comprises 4 or 8 valve positions.

The pneumatic and electrical linkage takes place in a fixed grid. Subsequent extension is not possible.

Two positions for input modules with 8 digital or 8 analogue inputs can be integrated in the Motion Terminal.

Sub-base valve

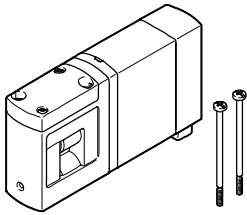

VTEM offers a comprehensive range of programmable valve functions. The valves comprise four 2/2-way proportional valves connected to form a full bridge. Each 2/2-way proportional valve is pilot controlled by two piezo valves.

The pilot air for all valves is supplied jointly via duct 14 (branched internally from duct 1 or supplied externally).

Sensors monitor the degree of opening of the valves as well as the pressure in duct 2 and 4.

4x 2/2-way proportional valve

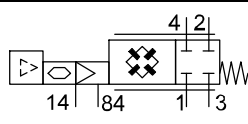
Circuit symbol	Code	Description
	Position function 1-8: C	<ul style="list-style-type: none"> • Bridge circuit • Single solenoid • Reset via mechanical spring <ul style="list-style-type: none"> • Operating pressure: 0 ... 8 bar • Vacuum operation at port 3 only

Cover plate

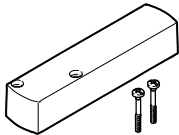

Vacant position (code L) without valve function, for reserving valve positions

or unused input module positions (seal).

Compressed air supply and exhaust

The Motion Terminal is supplied with compressed air via:

- Manifold rail
- Controller/pneumatic interface

Exhausting (duct 3) takes place via:

- Manifold rail
- Controller/pneumatic interface

The pilot air exhaust (duct 84) is completely separate from duct 3. The connection is on the controller (pneumatic interface to CPX terminal) together with the connections for duct 1 and 3.

All valves on the Motion Terminal have a common pilot air supply. They can be supplied as follows:

- Internally (from duct 1 of the manifold rail) or
- External (from duct 14)

Pressure zone separation (duct 1) is not required, as each valve can control the outlet pressure separately. For vacuum applications, a vacuum is connected to port 3 and pressure for the ejector pulse is connected to port 1.

Note

A filter must be installed upstream of the intake air getting into the valve (e.g. when operating a suction cup with connector). This prevents any foreign matter in

the intake air getting into the valve (e.g. when operating a suction cup with connector).

Motion Terminal VTEM

Characteristics – Pneumatic components

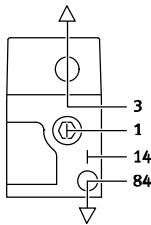
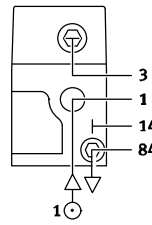
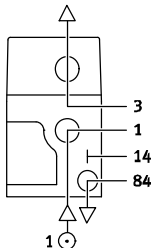
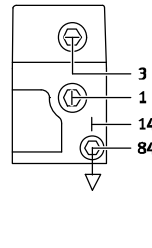
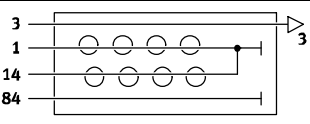
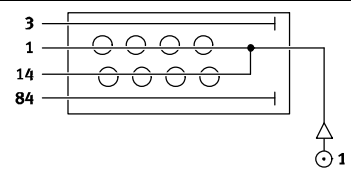
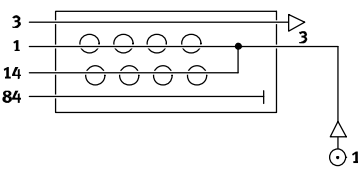
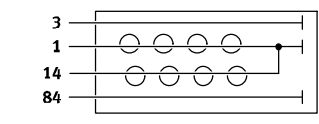
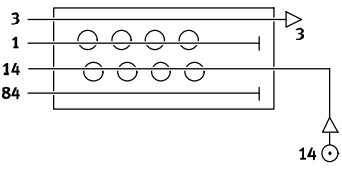
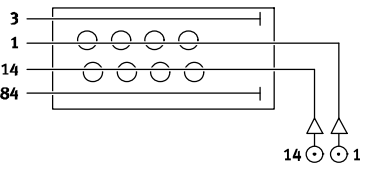
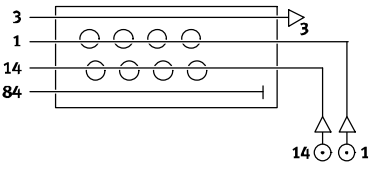
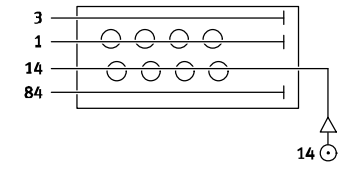
Compressed air supply and pilot air supply			
Graphical illustration	Description	Graphical illustration	Description
Controller			
	<ul style="list-style-type: none"> Exhaust via the controller Compressed air is supplied via the manifold rail Exhaust can also take place via the manifold rail 		<ul style="list-style-type: none"> Compressed air supply via the controller Exhaust takes place via the manifold rail Compressed air can also be supplied via the manifold rail
	<ul style="list-style-type: none"> Exhaust and compressed air supply via the controller Compressed air supply and exhaust alternatively possible via the manifold rail 		<ul style="list-style-type: none"> Ports on the controller sealed Compressed air supply and exhaust via the manifold rail
Manifold rail with internal pilot air supply			
	<ul style="list-style-type: none"> Exhaust via the manifold rail Compressed air supply via the controller Exhaust can also take place via the controller 		<ul style="list-style-type: none"> Compressed air supply via the manifold rail Exhaust takes place via the controller Compressed air can also be supplied via the controller
	<ul style="list-style-type: none"> Exhaust and compressed air supply via the manifold rail Compressed air supply and exhaust also possible via the controller 		<ul style="list-style-type: none"> Ports on the manifold rail sealed Compressed air supply and exhaust via the controller
Manifold rail with external pilot air supply			
	<ul style="list-style-type: none"> Exhaust via the manifold rail Compressed air supply via the controller Exhaust can also take place via the controller 		<ul style="list-style-type: none"> Compressed air supply via the manifold rail Exhaust takes place via the controller Compressed air can also be supplied via the controller
	<ul style="list-style-type: none"> Exhaust and compressed air supply via the manifold rail Compressed air supply and exhaust also possible via the controller 		<ul style="list-style-type: none"> Ports on the manifold rail sealed Compressed air supply and exhaust via the controller

Motion Terminal VTEM

Characteristics – Pneumatic components

Vacuum operation

Basic principles

The Motion Terminal VTEM can be operated with vacuum.

For vacuum operation, the vacuum is connected to port 3. Pressure for an ejector pulse can be connected at port 1.

When using internal pilot air supply, the necessary minimum pressure (3 bar) in duct 1 must be maintained. Internal pressure sensors in duct 2 and duct 4 detect the pressure/

vacuum and enable the valve to control its degree of opening and the pressure level.

The sensors are designed so they are protected against contamination.

 Note

A filter must be installed upstream of valves operated in vacuum mode. This prevents any foreign matter in the intake air getting into the valve (e.g. when operating a suction cup with connector).

Fittings

Port 1, 2, 3, 4, 14 and 84

The outlet direction of the pneumatic connections in the manifold rail is specified.

The outlet direction of connected tubing can be varied widely by choosing appropriate fittings.

Connection type and outlet direction are selected:

- for all ports 2 and 4
- for all compressed air supply ports
- for all exhaust ports

- for each individual port 2, as a deviation from the general specification
- for each individual port 4, as a deviation from the general specification

Connection on the valve (port 2/4)

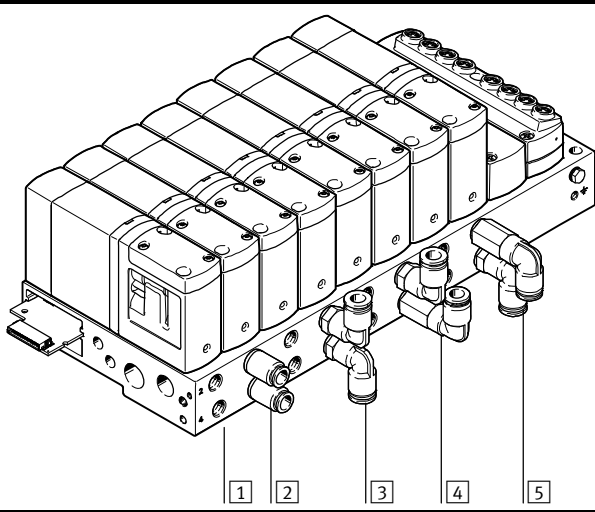
	Code	Description
	1	G18 Threaded connection G1/8
	2	Q... Valve connection: push-in connector ... Valve connection type: straight
	3	Q... FB Valve connection: push-in connector ... Valve connection type: angled upward and downward
	4	Q... FA Valve connection: push-in connector ... Valve connection type: angled upward
	5	Q... FC Valve connection: push-in connector ... Valve connection type: angled downward

Motion Terminal VTEM

Characteristics – Assembly

Motion Terminal assembly

Wall mounting

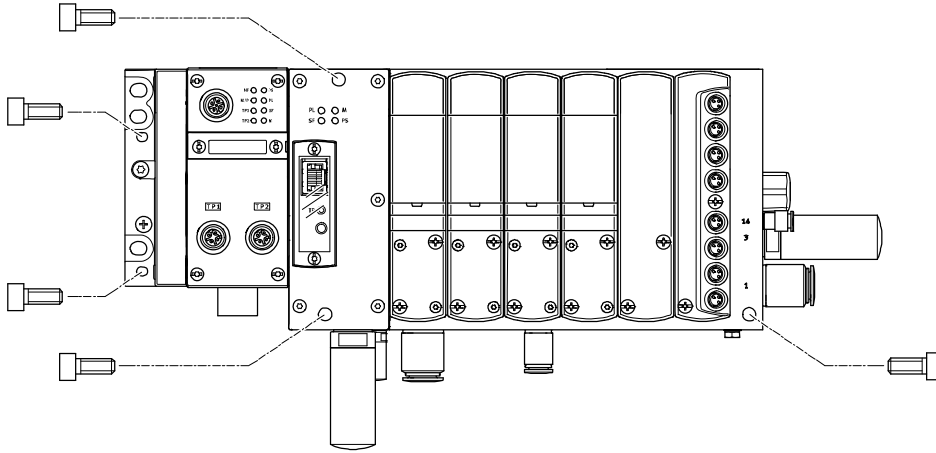

The Motion Terminal VTEM is screwed to the mounting surface using five M4 or M6 screws.

The mounting holes are located:

- On the left end plate (CPX)
- On the right-hand end of the manifold rail
- On the VTEM controller

H-rail mounting

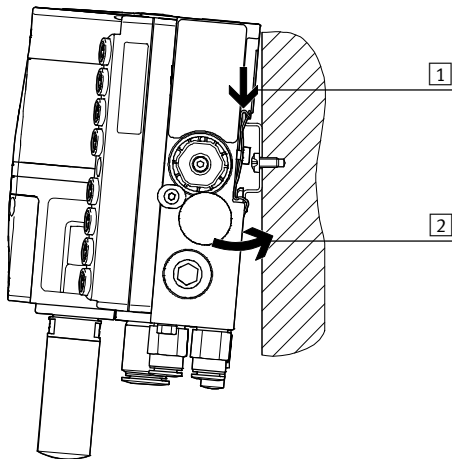

- 1 The Motion Terminal is hung on the H-rail
- 2 The Motion Terminal is then pivoted onto the H-rail and latched in place

Motion Terminal VTEM

Characteristics – Display and operation

Display and operation			
CPX terminal	VTEM controller	VTEM valve	VTEM input module
<p>The modules of the CPX terminal have a row of LEDs. These provide information about:</p> <ul style="list-style-type: none"> • Status of bus communication • System status • Module status 	<p>The VTEM controller has LEDs for displaying:</p> <ul style="list-style-type: none"> • Operating voltages • Status of communication to higher-order controller • Ethernet data traffic 	<p>Each VTEM valve has a display which indicates whether the valve is ready for operation or whether there is a malfunction.</p> <p>The valves do not have a mechanical manual override.</p>	<p>The input modules are equipped with one central ready status indication per module.</p> <p>The digital input module displays the input status for each channel.</p>

Display and control components

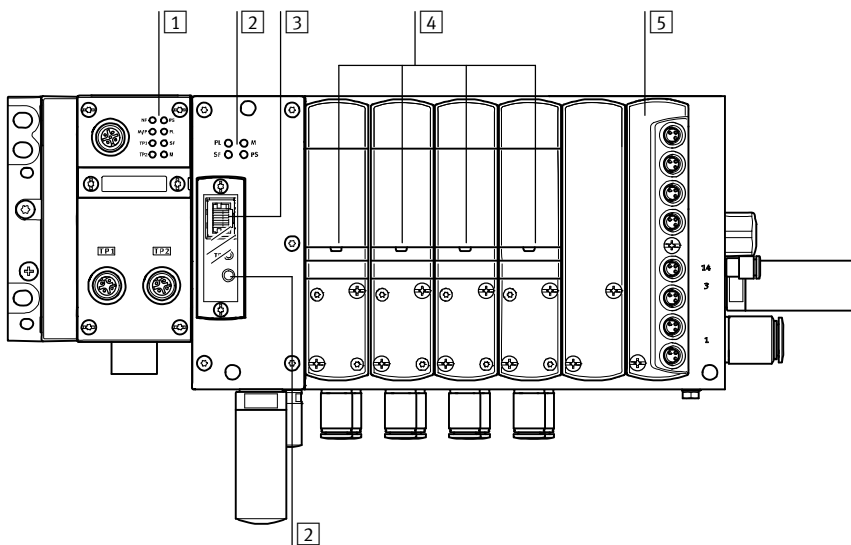

- 1 LED indicators on the bus node of the CPX terminal
- 2 LED indicators on the VTEM controller
- 3 Ethernet interface to the VTEM controller
- 4 LED indicator on the VTEM valve
- 5 VTEM input module

Diagnostics

Detailed support for diagnostic functions is needed in order to quickly locate the causes of errors in the electrical installation and therefore reduce downtimes in production plants.

A basic distinction is made between on-the-spot diagnostics using LEDs or an operator unit and diagnostics using a bus interface.

The Motion Terminal VTEM supports on-the-spot diagnostics using LEDs as well as diagnostics via bus interface and Ethernet interface.

Labelling

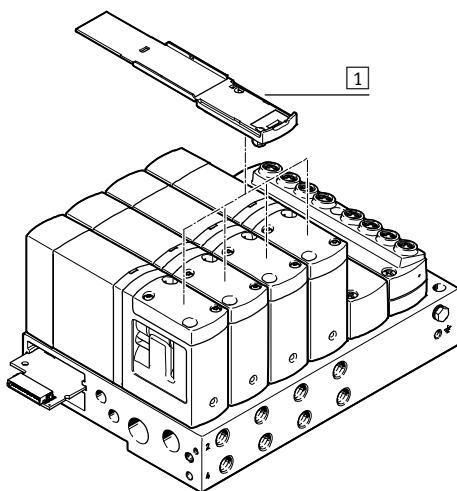



- 1 Identification holder

Identification holders are available for labelling the Motion Terminal. These are clipped onto the valves.

Motion Terminal VTEM

Technical data – Motion Terminal VTEM

-  - Flow rate
Up to 480 l/min

-  - Valve width
27 mm

-  - Voltage
24 V DC



General technical data	
Design	Fixed grid
Electrical control	Fieldbus
Type of actuation	Electrical
Maximum number of valve positions	8
Valve size	[mm] 27
Grid dimension	[mm] 28
Suitable for vacuum	Yes
Exhaust function	Without flow control option
Pilot air supply	Internal or external
Electrical I/O system	Yes
Degree of protection	IP65

Operating and environmental conditions	
Operating medium	Compressed air to ISO 8573-1:2010 [7:4:4] and inert gases
Pilot medium	Compressed air to ISO 8573-1:2010 [7:4:4]
Note on operating/pilot medium	Lubricated operation not possible
Operating pressure	[bar] 3 ... 8
Pilot pressure	[bar] 3 ... 8
Note on operating/pilot pressure	0 ... 8 bar for external pilot air supply Vacuum at port 3 only
Ambient temperature	[°C] -5 ... +50
Temperature of medium	[°C] -5 ... +50
Storage temperature	[°C] -20 ... +40
Relative humidity	[%] 0 ... 90 (non-condensing)
Corrosion resistance class CRC ¹⁾	2
CE marking (see declaration of conformity)	To EU EMC Directive ²⁾
	To EU Low Voltage Directive
Material fire test	UL94 HB

1) Corrosion resistance class CRC 2 to Festo standard FN 940070
Moderate corrosion stress. Indoor applications in which condensation may occur. External visible parts with primarily decorative requirements for the surface and which are in direct contact with the ambient atmosphere typical for industrial applications.

2) For information about the applicability of the component see the manufacturer's EC declaration of conformity at: www.festo.com/sp → User documentation.
If the component is subject to restrictions on usage in residential, office or commercial environments or small businesses, further measures to reduce the emitted interference may be necessary.

Motion Terminal VTEM

Technical data – Motion Terminal VTEM



Electrical data		
Nominal operating voltage	[V DC]	24
Permissible voltage fluctuations	[%]	±25
Protection against direct and indirect contact		PELV

Safety data	
CE marking (see declaration of conformity)	To EU EMC Directive ¹⁾ To EU Low Voltage Directive
Shock resistance	Shock test with severity level 2 to FN 942017-5 and EN 60068-2-27
Vibration resistance	Transport application test with severity level 2 to FN 942017-4 and EN 60068-2-6
Note on vibration/shock resistance	Static installation only when mounting with H-rail

- 1) For information about the applicability of the component see the manufacturer's EC declaration of conformity at: www.festo.com/sp → User documentation.
If the component is subject to restrictions on usage in residential, office or commercial environments or small businesses, further measures to reduce the emitted interference may be necessary.

Pneumatic connections		
Supply	1	G3/8 thread
Exhaust port	3	G3/8 thread
Pilot air supply	14	M5 thread
Pilot exhaust air	84	M7 thread
Venting hole		M7 thread
Working ports	2	G1/8 thread
	4	G1/8 thread

Materials	
Seals	TPE-U(PU), NBR
Note on materials	RoHS-compliant Contains paint-wetting impairment substances

Product weight	
	Approx. weight [g]
Controller	290
Manifold rail, 4 valve positions	990 1460 (with 2 vacant positions for input modules)
Manifold rail, 8 valve positions	1875 2340 (with 2 vacant positions for input modules)
Cover plate	75
Valve body	200
Input module	75

Motion Terminal VTEM

Technical data – Motion Terminal VTEM

Connection and display components

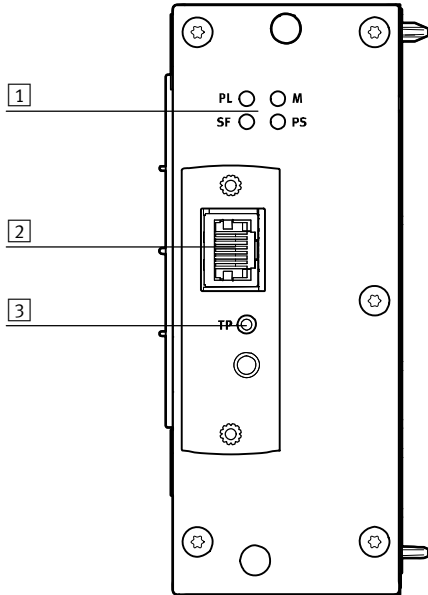

- 1 Diagnostics LED
- 2 Ethernet interface for system configuration
- 3 Status LED for Ethernet interface

Dimensions

Download CAD data → www.festo.com

Front view

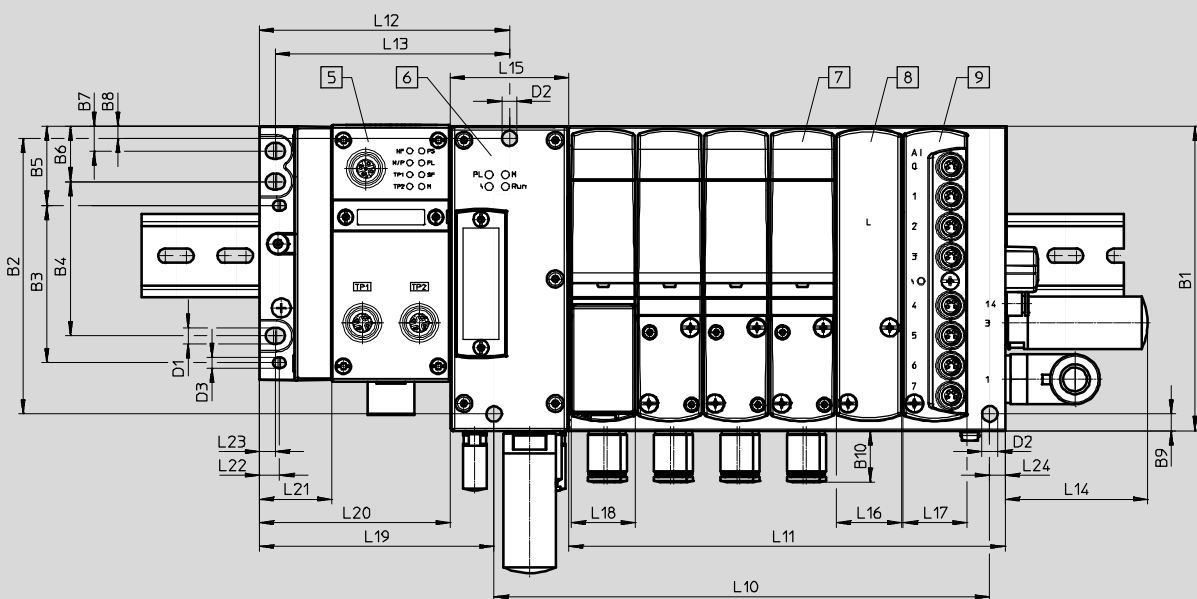

- 5 CPX bus node
- 6 Controller
- 7 Valve VEVM
- 8 Cover plate
- 9 Input module CTMM

Type code	B1	B2	B3	B4	B5	B6	B7	B8	B9	B10	D1	D2	D3
VTEM	128.5	116.2	66.3	65	33.5	23.5	10.5	5.2	7.1	21.6	6.6	6.6	4.4

Type code	Number of valve positions	L10	L11	L12	L13	L14	L15	L16	L17	L18	L19	L20	L21	L22	L23	L24
VTEM	4	153	128	105.5	98.8	60	50	27.5	27	27	99	80.5	30.6	8.5	6.8	6.5
	6	209	184													
	8	265	240													
	10	321	296													

Motion Terminal VTEM

Technical data – Motion Terminal VTEM

Dimensions

Download CAD data → www.festo.com

Horizontal view

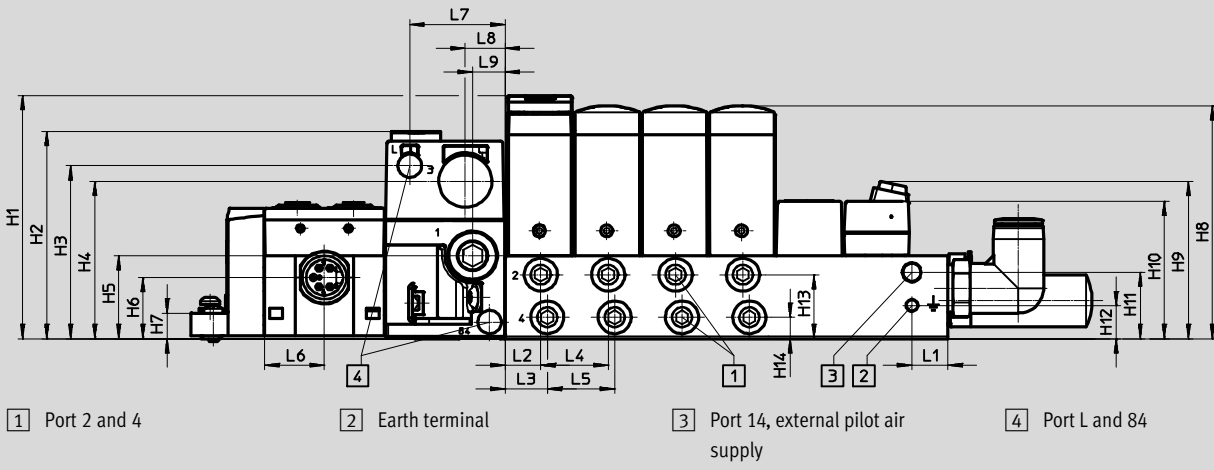

Type code	H1	H2	H3	H4	H5	H6	H7	H8	H9	H10	H11	H12	H13	H14
VTEM	102.7	87.5	73	66.5	35	25.8	10.8	98.4	66.3	58	28	14	27	9

Type code	L1	L2	L3	L4	L5	L6	L7	L8	L9
VTEM	14.9	14.9	17.6	28	28	24.9	39.6	16.5	13.5

Side view

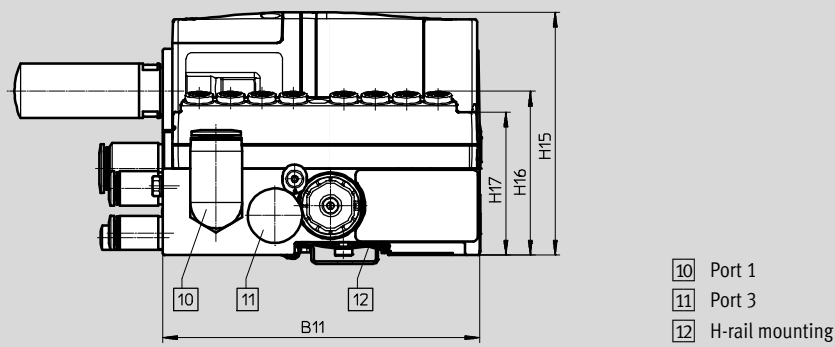

Type code	B11	H15	H16	H17
VTEM	128.5	98.4	66.3	58

Motion Terminal VTEM

Technical data – Valves VEVM

 Flow rate
480 l/min

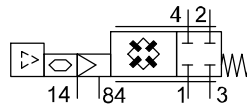

 Valve width
27 mm

 Voltage
24 V DC



General technical data		
Valve function	Can be assigned using Motion App	
Motion Apps	Directional control valve functions	
	Proportional directional control valve	
	Proportional pressure regulation	
	Supply and exhaust air flow control	
	ECO drive	
	Presetting of travel time	
	Selectable pressure level	
Leakage diagnostics		
Reset method	Mechanical spring	
Design	Piston seat	
Sealing principle	Soft	
Type of actuation	Electrical	
Type of control	Piloted	
Pilot air supply	External	
Flow direction	Not reversible; pressure at 1 and exhaust or vacuum at 3	
Suitability for vacuum	Yes	
Exhaust function	Without flow control option	
Mounting position	Any	
Nominal width	[mm] 4.2	
Standard nominal flow rate	[l/min] 480	
Valve size	[mm] 27	
Grid dimension	[mm] 28	
Ports on the sub-base	1, 3	G3/8
	2, 4	G1/8
	14	M5
	84	M7
Product weight	[g] 200	
Degree of protection to EN 60529	IP65	

Switching times			
Switching time	On	[ms]	8.5
	Off	[ms]	8.5
Response time		[ms]	max. 45

Motion Terminal VTEM

Technical data – Valves VEVM

FESTO

Operating and environmental conditions	
Operating medium	Compressed air to ISO 8573-1:2010 [7:4:4] Inert gases
Pilot medium	Compressed air to ISO 8573-1:2010 [7:4:4]
Note on operating/pilot medium	Lubricated operation not possible
Operating pressure [bar]	3 ... 8
Pilot pressure [bar]	3 ... 8
Note on operating pressure	0 ... 8 bar for external pilot air supply Vacuum operation at port 3 only
Ambient temperature [°C]	-5 ... +50
Temperature of medium [°C]	-5 ... +50
Storage temperature [°C]	-20 ... +40
Relative humidity [%]	0 ... 90 (non-condensing)
Corrosion resistance class CRC ¹⁾	2
CE mark (see declaration of conformity) ³⁾	To EU EMC Directive ²⁾ To EU Low Voltage Directive
Material fire test	UL94 HB

- 1) Corrosion resistance class CRC 2 to Festo standard FN 940070
Moderate corrosion stress. Indoor applications in which condensation may occur. External visible parts with primarily decorative requirements for the surface and which are in direct contact with the ambient atmosphere typical for industrial applications.
- 2) For information about the applicability of the component see the manufacturer's EC declaration of conformity at: www.festo.com/sp → User documentation.
If the component is subject to restrictions on usage in residential, office or commercial environments or small businesses, further measures to reduce the emitted interference may be necessary.
- 3) Additional information www.festo.com/sp → Certificates.

Electrical data	
Electrical connection	Via sub-base
Nominal operating voltage [V DC]	24
Permissible voltage fluctuations [%]	±25
Power consumption [W]	1.25
Status indication	Blue LED (valve in operation) Red LED (malfunction)
Duty cycle [%]	100

Materials	
Housing	PA
Seals	TPE-U(PU), NBR
Note on materials	RoHS-compliant Contains paint-wetting impairment substances

Motion Terminal VTEM

Technical data – Input module

Function

Input modules enable analogue and digital sensors to be connected to the Motion Terminal.
The input signals are used for motion tasks, but can also be looped through from a Motion App to the higher-order controller.

Area of application

- Input modules for 24 V DC sensor supply voltage
- Digital module with PNP logic
- Analogue module for 4 ... 20 mA

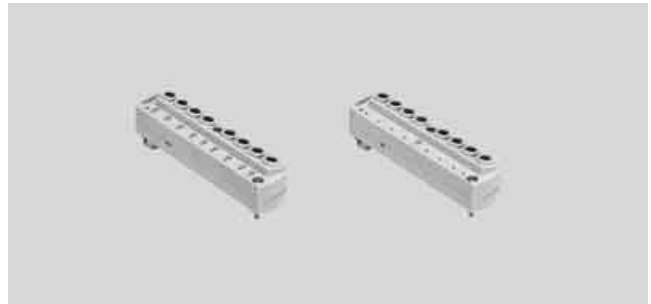

General technical data		Digital input module	Analogue input module
Electrical connection	Function	Digital input	Analogue input
	Connection type	8x socket	8x socket
	Connection technology	M8x1, A-coded to EN 61076-2-104	M8x1, A-coded to EN 61076-2-104
	Number of pins/wires	3	4
Number of inputs		8	8
Number of outputs		0	0
Input characteristic curve		To IEC 61131-2, type 2	IEC1131-T2
Input signal range		Signal 0: ≤ 5 V	4 ... 20 mA
		Signal 1: ≥ 11 V	
Input debounce time	[ms]	0.1	–
Input switching logic		PNP	–
Measured variable		–	Current
Fuse protection		Internal electronic fuse	Internal electronic fuse
Electrical isolation	Channel – internal bus	None	None
	Channel – channel	None	None
Diagnostics via LED		Fault per module	Fault per module
		Status per channel	–
Nominal operating voltage	[V DC]	24	
Permissible voltage fluctuations	[%]	±25	
Intrinsic current consumption at nominal operating voltage	[mA]	Typically 12	
Maximum cable length	[m]	30	
Dimensions	W x L x H	[mm]	27 x 123 x 40
Grid dimension		[mm]	28
Product weight		[g]	75
Degree of protection		IP65/IP67	

Materials	
Housing	PA
Note on materials	RoHS-compliant

Operating and environmental conditions		
Ambient temperature	[°C]	–5 ... +50
Temperature of medium	[°C]	–5 ... +50
Storage temperature	[°C]	–20 ... +40
Corrosion resistance class CRC ¹⁾		2
CE marking (see declaration of conformity)		To EU EMC Directive ²⁾

1) Corrosion resistance class CRC 2 to Festo standard FN 940070
Moderate corrosion stress. Indoor applications in which condensation may occur. External visible parts with primarily decorative requirements for the surface and which are in direct contact with the ambient atmosphere typical for industrial applications.

2) For information about the applicability of the component see the manufacturer's EC declaration of conformity at: www.festo.com/sp → User documentation.
If the component is subject to restrictions on usage in residential, office or commercial environments or small businesses, further measures to reduce the emitted interference may be necessary.

Motion Terminal VTEM

Technical data – Input module

Safety data	
CE marking (see declaration of conformity)	To EU EMC Directive ¹⁾
Shock resistance	Shock test with severity level 2 to FN 942017-5 and EN 60068-2-27
Vibration resistance	Transport application test with severity level 2 to FN 942017-4 and EN 60068-2-6

1) For information about the applicability of the component see the manufacturer's EC declaration of conformity at: www.festo.com/sp → User documentation.
If the component is subject to restrictions on usage in residential, office or commercial environments or small businesses, further measures to reduce the emitted interference may be necessary.

Connection and display components

Input module with digital inputs

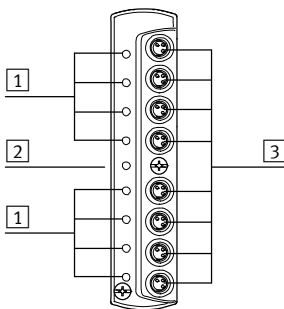

- 1 Status LEDs for inputs (status indicator, green)
- 2 Status LED (module) for short circuit/overload of sensor supply (red)
- 3 Sensor connections

Input module with analogue inputs

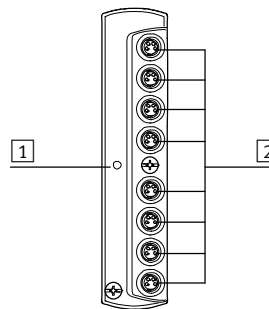

- 1 Status LED (module) for short circuit/overload of sensor supply (red)
- 2 Sensor connections

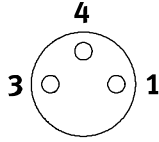
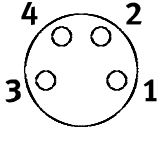

Pin allocation for sensor connections

Pin allocation	Pin	Signal	Designation	Pin allocation	Pin	Signal	Designation
Input module with digital inputs				Input module with analogue inputs			
	1	24 V	Operating voltage 24 V		1	24 V	Operating voltage 24 V
	3	0V	Operating voltage 0 V		2	Ix*	Sensor signal
	4	Ix*	Sensor signal		3	0V	Operating voltage 0 V
					4	n.c.	Not connected

* Ix = Input x

Motion Terminal VTEM

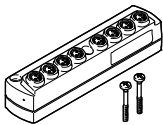
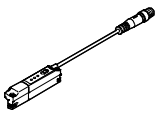
Technical data – Input module

Ordering data					
			Part no.	Type code	PU ¹⁾
Input module					
	Module with 8 inputs	Digital inputs	8047505	CTMM-S1-D-8E-M8-3	1
		Analogue inputs	8047506	CTMM-S1-A-8E-A-M8-4	1
Position sensor					
	Analogue sensor for VTEM input module	Sensing range 0 ... 50 mm	8050120	SDAP-MHS-M50-1L-A-E-0.3-M8	1
		Sensing range 0 ... 100 mm	8050121	SDAP-MHS-M100-1L-A-E-0.3-M8	1
		Sensing range 0 ... 160 mm	8050122	SDAP-MHS-M160-1L-A-E-0.3-M8	1
Connecting cable Technical data → Internet: nebu					
	Modular system for any connecting cable	Cable length 0.1 ... 30 m	539052	NEBU-... → Internet: nebu	–
		<ul style="list-style-type: none"> • Straight plug, 4-pin • Straight socket, M8x1, 4-pin 	Cable length 2.5 m	554035	NEBU-M8G4-K-2.5-M8G4
Cover cap					
	Cover cap for sealing unused ports	For M8 connections	177672	ISK-M8	10

1) Packaging unit.

Motion Terminal VTEM

Technical data – Motion App “Directional control valve functions”

- 2x 2/2-way valve
- 2x 3/2-way valve
- 4/2-way valve
- 4/3-way valve
- Included in the Basic package

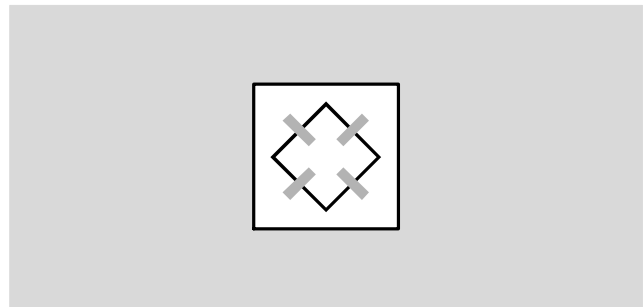

Description		
Mode of operation	Benefits	Scope
<p>The directional control valve function allows the characteristics of a conventional pneumatic valve to be assigned to a valve position.</p> <p>The integrated sensors enable the switching position to be monitored.</p> <p>All ducts are blocked if the pilot pressure or power supply is interrupted.</p>	<p>The ability to assign the directional control valve function significantly reduces component variety. This in turn reduces the initial design costs.</p> <p>If a replacement is required, it is no longer necessary to identify the specific valve; the controller assigns the function to the new valve.</p> <p>Thanks to the cyclical assignment, a series of valve functions can be realised on one valve position at different times.</p>	<p>During maintenance and commissioning, the valves can be stopped as required via the controller and can exhaust the system.</p> <ul style="list-style-type: none"> • One valve position with nine valve functions • No need to change the valve for a different valve function • Virtual manual override via software, access via Ethernet interface
		<p>For the entire Motion Terminal</p> <ul style="list-style-type: none"> • For each individual valve position in a Motion Terminal, depending on the assignment • Cyclical assignment
		<p>Data</p> <p>Controller to the valve</p> <ul style="list-style-type: none"> • Directional control valve function • Switching position to be assumed <p>Valve to the controller</p> <ul style="list-style-type: none"> • Switching position • Pressure in duct 2 • Pressure in duct 4

Valve functions			
Circuit symbol	Description	Circuit symbol	Description
2x 3/2-way valve		4/3-way valve	
	<ul style="list-style-type: none"> • Bistable • Normally open • Non-reversible 		<ul style="list-style-type: none"> • Mid-position pressurised • Non-reversible
	<ul style="list-style-type: none"> • Bistable • Normally closed • Non-reversible 		<ul style="list-style-type: none"> • Mid-position closed • Non-reversible
	<ul style="list-style-type: none"> • Bistable • Normal position <ul style="list-style-type: none"> – 1x closed – 1x open • Non-reversible 		<ul style="list-style-type: none"> • Mid-position exhausted • Non-reversible
4/2-way valve		2x 2/2-way valve	
	<ul style="list-style-type: none"> • Monostable • Pneumatic reset • Non-reversible 		<ul style="list-style-type: none"> • Bistable • Normally closed • Non-reversible
	<ul style="list-style-type: none"> • Bistable • Non-reversible 		

Motion Terminal VTEM

Technical data – Motion App “Directional control valve functions”

Technical data		
Switching time	On [ms]	< 8.5
	Off [ms]	< 8.5
Flow rate	[l/min]	480 ±15%

Motion Terminal VTEM

Technical data – Motion App “Proportional directional control valve”

- 4/3-way proportional valve
- 2x 3/3-way proportional valve
- Included in the Start package

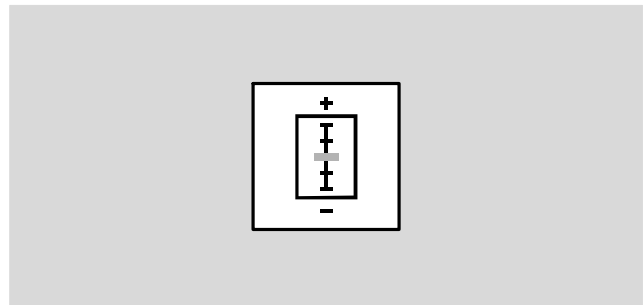

Description

Mode of operation

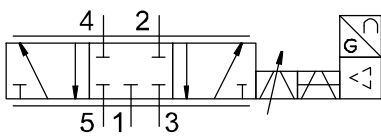

The proportional directional control valve function is assigned to a valve position in the same way as the directional control valve function.

The integrated sensors enable the switching position and degree of opening of the valves to be monitored.

Benefits

- Minimal leakage (poppet valves)
- Low current consumption
- Two independently controlled ports at one valve position
- Different control characteristics can be set

Scope

- For the entire Motion Terminal
- For each individual valve position in a Motion Terminal, depending on the assignment
- Cyclical assignment

Data

Controller to the valve

- Directional control valve function
- Switching position to be assumed
- Control characteristics
- Valve position (–100 ... +100%)
- Duct blocking

Valve to the controller

- Measured valve position (–100 ... +100%)

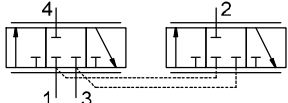
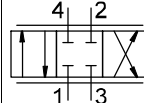
Valve functions	
Circuit symbol	Description
	<ul style="list-style-type: none"> • Mid-position closed • Non-reversible
	<ul style="list-style-type: none"> • Mid-position closed • Non-reversible

Technical data		
FS (full scale) linearity	[%]	< 2
FS (full scale) repetition accuracy	[%]	< 1.5
Maximum FS (full scale) hysteresis	[%]	< 1.5
FS (Full scale) response sensitivity	[%]	< 1.5

Motion Terminal VTEM

Technical data – Motion App “Proportional pressure regulation”

 Pressure -0.9 ... +7 bar

- Pressure regulation in c2
- Pressure regulation in duct 4
- Licences for the number of simultaneous usages required

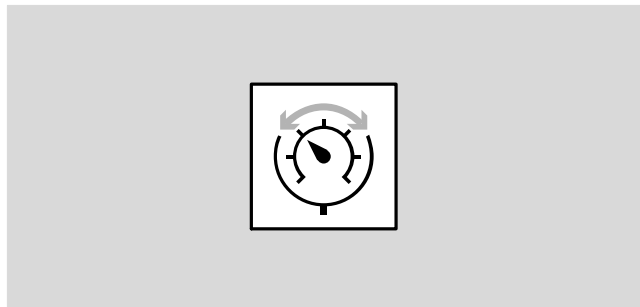

Description

Mode of operation

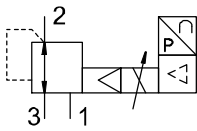

The proportional pressure regulation function enables the pressure at ducts 2 and 4 to be regulated independently

Thanks to the integrated sensors, the pressure can be precisely monitored.

The following control characteristics are available:

- Small volume
- Medium volume
- Large volume
- Self-configured setting

For vacuum applications, a vacuum is connected at duct 3. Pressure, for an ejector pulse for example, can be connected at duct 1 at the same time.

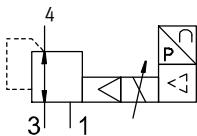

Benefits

- Two pressure regulators per valve position
- Easy parameterisation
- Vacuum regulation

Scope

- For the entire Motion Terminal
- For each individual valve position in a Motion Terminal, depending on the assignment
- Cyclical assignment

Data

- Controller to the valve
- Pressure at duct 2 (setpoint value)
 - Pressure at duct 4 (setpoint value)
- Valve to the controller
- Pressure at duct 2 (actual value)
 - Pressure at duct 4 (actual value)

Range of application

- Control of force with known effective area
- Control of contact pressure
- Actuating process valves
- Vacuum control with ejector pulse

Technical data

Parameter	Unit	Value	Typical Value	Conditions:
Linearity error	[mbar]	100	Typically 60	<ul style="list-style-type: none"> • Valid in the range 5 ... 95% of the setpoint value • Supply pressure: 8 bar • Volume 0.1 l • Control characteristics: C1 • Only one pressure regulator active within the valve terminal • Based on the ideal characteristic curve in the range -0.7 ... 7 bar
Repetition accuracy	[mbar]	50	Typically 25	
Maximum hysteresis	[mbar]	50	Typically 25	
Overall accuracy	[mbar]	120	Typically 80	

Pressure as a function of flow rate

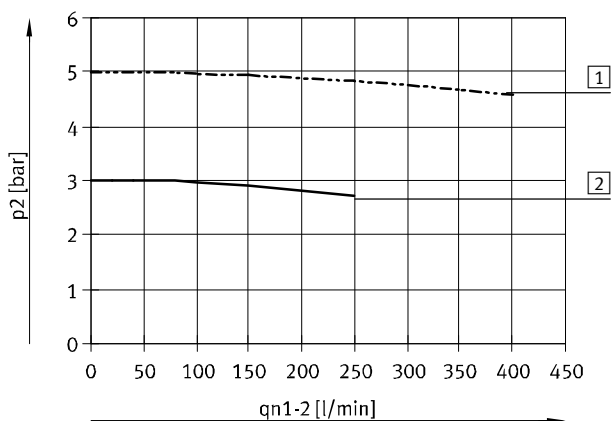

- 1 Characteristic pressure curve with a specified setpoint value of 5 bar
- 2 Characteristic pressure curve with a specified setpoint value of 3 bar

Motion Terminal VTEM

Technical data – Motion App “Supply and exhaust air flow control”

- Supply air flow control
- Exhaust air flow control
- Included in the Start package

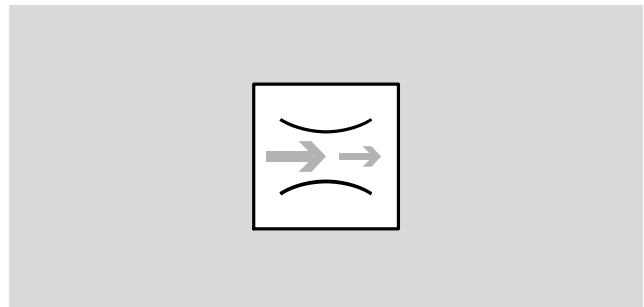

Description

Mode of operation

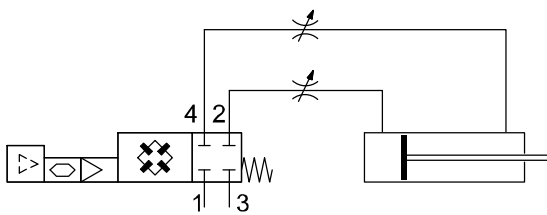

The flow rate can be individually adjusted for each duct; the supply air and exhaust air flow control are adjusted independently one another.

It is no longer necessary to have a technician on site to change the flow control.

Benefits

- Flow control remotely adjustable during operation (adjustment via controller)
- Reproducible flow control cross sections adjustable via controller
- Reduced component variety since there is no mechanical flow control valve
- Flow control setting can be called up during operation
- Tamper-proof

Scope

- For the entire Motion Terminal
- For each individual valve position in a Motion Terminal, depending on the assignment
- Cyclical assignment
- Control precision $\pm 3\%$

Data

Controller to the valve

- Supply air flow control setting
0 ... 100%
(recommended values: 5 ... 100%)
- Exhaust air flow control setting
0 ... 100%
(recommended values: 5 ... 100%)
- Increments 0.01%

Valve to the controller

- Supply air flow control setting
- Exhaust air flow control setting

Pre-pressurisation function

If, on starting the Motion App, the pressure at port 2 and 4 is more than 50% below the current pressure in duct 1, it is steadily increased until the specified value has been reached. The actual motion task then starts.

This function prevents advancing to the end position in an uncontrolled manner.

Motion Terminal VTEM

Technical data – Motion App “ECO drive”

- Supply air flow control with end-position switch-off
- Can be used for advancing and retracting the cylinder in an energy-saving manner

Additionally required:

- A digital input module CTMM
- Two digital sensors (PNP, N/O contact) for determining the end position of the drive



Description

Mode of operation

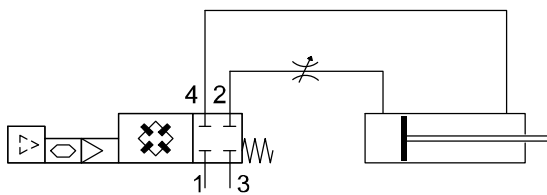

To save energy during cylinder movement, the supply air flow is controlled when advancing the cylinder while the exhaust air is not subject to flow control. The supply air side is shut off when the end position is reached so the pressure level and cylinder position can be maintained.

For this function, the cylinder position is sensed via two end-position switches. For safe functioning, a horizontal travel movement/mounting position is recommended. The acceleration and speed of the movement are significantly increased by a force acting in the same direction.

Pressure curve without ECO drive

Pressure at duct 2

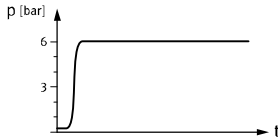

Pressure at duct 4

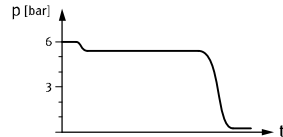

- High pressure at duct 2
- High pressure at duct 4
- Supply air not subject to flow control
- Exhaust air flow control

- Differential pressure in line with the amount of force required for the movement
- High force in the end position
- High energy consumption

Pressure curve with ECO drive

Pressure at duct 2

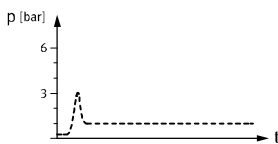

Pressure at duct 4

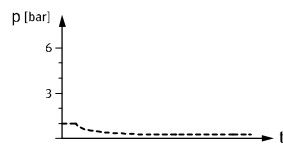

- Low pressure at duct 2
- Low pressure at duct 4
- Supply air flow control
- Exhaust air not subject to flow control

- Differential pressure in line with the amount of force required for the movement
- Low force in the end position
- Low energy consumption

Benefits

- Supply air flow control and pressure switch-off in the end position considerably increase energy efficiency
- Energy/pressure consumption is automatically adapted to the load
- Readjustment in case of deviation from the end position
- Suitable for moving low loads at low speed

Scope

- For the entire Motion Terminal
- For each individual valve position in a Motion Terminal, depending on the assignment
- Cyclical assignment

Data

Controller to the valve

- Supply air flow control setting 5 ... 100%

Valve to the controller

- Pressure at duct 2
- Pressure at duct 4
- End position reached

Motion Terminal VTEM

Technical data – Motion App “Presetting of travel time”

- Self-learning exhaust air flow control for regulating the travel time

- Also required:
- A digital input module CTMM
 - Two digital sensors (PNP, N/O contact) for determining the end position of the drive

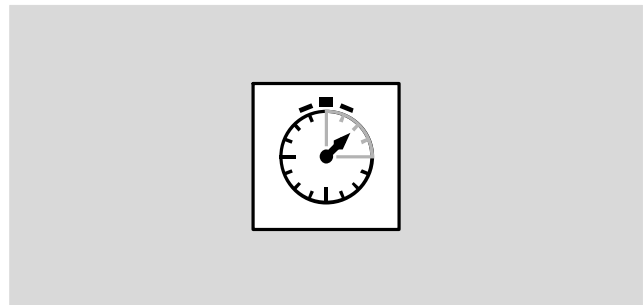

Description

Mode of operation

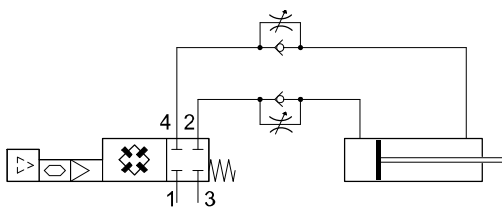

The travel time for retracting and advancing is preset in the Motion Terminal VTEM. The real travel time is autonomously determined using the sensor data and the exhaust air flow control is adapted until the specified travel time is achieved.

Continuous monitoring and adaptation compensate for changes to the system. Significant deviations in the parameters (deviating idle times, rapid change in external forces/friction forces) can cause deviations in travel time. End-position cushioning must be implemented separately.

Benefits

- Adaptive and self-adjusting
- Constant cycle times
- Travel time can be changed via the controller
- Variations in the supply or exhaust air pressure are automatically sensed and taken into consideration
- Password-protected access
- A simple proximity sensor is used

Scope

- For the entire Motion Terminal
- For each individual valve position in a Motion Terminal, depending on the assignment
- Cyclical assignment
- In combination with end-position switches

Data

- | | |
|------------------------------|-------------------------|
| Controller to the valve | Valve to the controller |
| • Advancing | • Measured travel time |
| • Retracting | • End position reached |
| • Exhausting both chambers | |
| • Shutting off both chambers | |

Pre-pressurisation function

If, on starting the Motion App, the pressure at port 2 and 4 is more than 20% below the current pressure in duct 1, it is steadily increased until the specified value has been reached. The actual motion task then starts.

This function prevents advancing to the end position in an uncontrolled manner.

Technical data

Repetition accuracy	[%]	3
Maximum repetition accuracy	[ms]	±20

Motion Terminal VTEM

Technical data – Motion App “Selectable pressure level”

- Pressure regulation at duct 2 and flow rate at duct 4
- Pressure regulation at duct 4 and flow rate at duct 2
- Included in the Start package

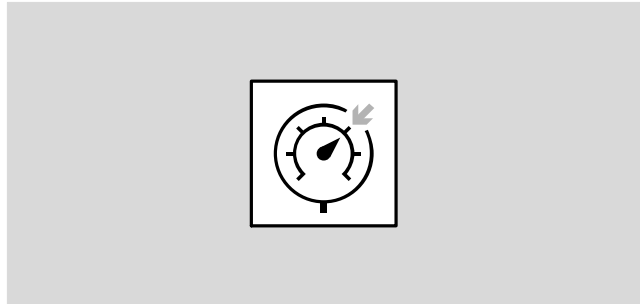

Description

Mode of operation

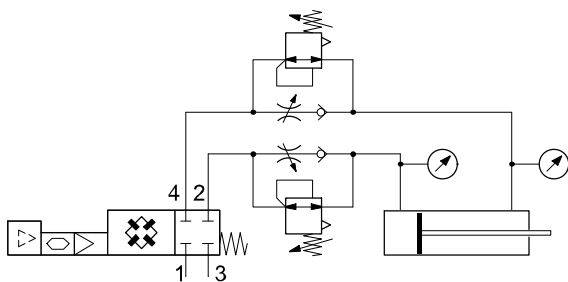

A desired setpoint value can be specified for ducts 2 and 4 independently of each other. The Motion Terminal VTEM autonomously regulates the pressure and signals the actual pressure in ducts 2 and 4 and to the higher-order controller.

Pressure regulation takes place in the pressurised duct, while the preset exhaust air flow is controlled in the other duct. Variably adjustable pressures in the end position enable a defined force (e.g. press-fitting) to be reproduced in the application.

Benefits

- Energy-saving movement with reduced pressure
- Pressure regulation in the end position
- Pressure can be changed remotely and individually preset for each drive and direction of movement

Scope

- For the entire Motion Terminal
- For each individual valve position in a Motion Terminal, depending on the assignment
- Cyclical assignment
- For cylinders with pneumatic cushioning

Data

Controller to the valve

- Pressure at duct 2 and flow control opening at duct 4
- Pressure at duct 4 and flow control opening at duct 2
- Stopping
- Advancing
- Retracting
- Exhausting both chambers

Valve to the controller

- Press at duct 2 and duct 4

Pre-pressurisation function

If, on starting the Motion App, the pressure at port 2 and 4 is below 2 bar, it is increased steadily until the specified value has been reached. The actual motion task then starts.

This function prevents advancing to the end position in an uncontrolled manner.

Technical data

Linearity error	[mbar]	100	Typically 60	Conditions: • Valid in the range 5 ... 95% of the setpoint value • Supply pressure: 8 bar • Volume Q1 l • Control characteristics: C1 • Only one pressure regulator active within the valve terminal • Based on the ideal characteristic curve in the range -0.7 ... 7 bar
Repetition accuracy	[mbar]	50	Typically 25	
Maximum hysteresis	[mbar]	50	Typically 25	
Overall accuracy	[mbar]	120	Typically 80	

Motion Terminal VTEM

Technical data – Motion App “Leakage diagnostics”

 Flow rate
Measuring range 2 ... 50 l/h

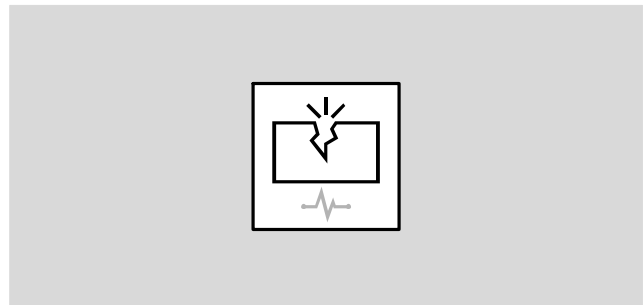

Description

Mode of operation

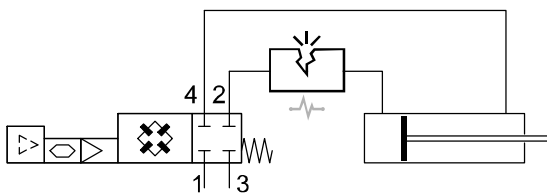

To calculate the leaks, the pressure drop will be determined at a valve (drive in end position). To be able to evaluate this value, a reference value is determined using a measurement taken at the start of the observation period. The Motion Terminal VTEM compares the value of further measurements against this reference value. This comparison provides the basis

for an evaluation using adjustable limits. The evaluation and the difference between the currently measured value and the reference value are fed back. During the diagnostics, the motion task independently advances and retracts the cylinder. Leakage testing is not performed during operation; it is started separately as a test cycle.

Benefits

Increased leakage can be caused by a critical fault (damaged tubing) or by wear and aging of the connected components.

Regular leakage testing can therefore:

- Determine a sudden leak
- Detect wear to cylinders and valves in good time

Scope

- For all valve positions of a Motion Terminal
- Requires a measurement run

- Not for vacuum applications
- For all types of pneumatic consumers

Data

Controller to the valve

- Starting diagnostics
- Terminating diagnostics
- Starting reference measurement
- Terminating reference measurement
- Exhausting

Valve to the controller





- Detecting the status
- Change in leakage for duct 2
- Change in leakage for duct 4
- Evaluating leakage for duct 2
- Evaluating leakage for duct 4

Technical data

Repetition accuracy	[l/h]	$\pm(2+0.15 \times \text{leakage})$	Conditions: <ul style="list-style-type: none"> • Temperature 10 ... 30 °C • Supply pressure: 0.5 ... 8 bar • A force acting on the connected drive should amount to max. 75% of the effective pneumatic force • Tube length < 2000 mm
---------------------	-------	-------------------------------------	--

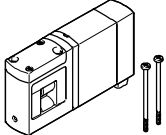
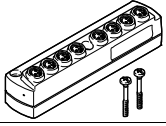
Motion Terminal VTEM

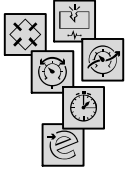
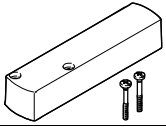
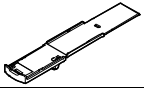

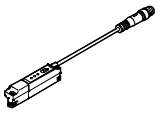
Accessories

Ordering data			Part no.	Type code	PU ¹⁾
Valve					
	Valve for one valve position		8047503	VEVM-S1-27-B-C-F-1T1L	1
Input module					
	Module with 8 inputs	Digital inputs	8047505	CTMM-S1-D-8E-M8-3	1
		Analogue inputs	8047506	CTMM-S1-A-8E-A-M8-4	1
	Cover cap for sealing unused ports	For M8 connections	177672	ISK-M8	10
Motion App					
	Start package	Motion Apps included: • Proportional directional control valve • Supply and exhaust air flow control • Selectable pressure level	8073515	GAMM-A0	1
	Directional control valve functions		8070377	GAMM-A1	1
	Proportional directional control valve		8070378	GAMM-A2	1
	Proportional pressure regulation		8072609	GAMM-A3	1
	Supply and exhaust air flow control		8072611	GAMM-A5	1
	ECO drive		8072612	GAMM-A6	1
	Presetting of travel time		8072613	GAMM-A7	1
	Selectable pressure level		8072614	GAMM-A8	1
Leakage diagnostics		8072616	GAMM-A12	1	
Accessories					
	Cover plate for a valve position or input module position		8047504	VABB-P11-27-T	1
	Identification holder for one valve		8047501	ASCF-H-P11	4
	H-rail mounting		8047542	VAME-P11-MK	1
Position sensor					
	Analogue sensor for VTEM input module	Sensing range 0 ... 50 mm	8050120	SDAP-MHS-M50-1L-A-E-Q3-M8	1
		Sensing range 0 ... 100 mm	8050121	SDAP-MHS-M100-1L-A-E-Q3-M8	1
		Sensing range 0 ... 160 mm	8050122	SDAP-MHS-M160-1L-A-E-Q3-M8	1

Motion Terminal VTEM

Accessories

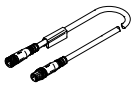

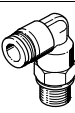
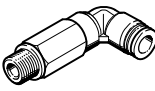
Ordering data		Part no.	Type code	PU ¹⁾
Connecting cable		Technical data → Internet: nebu		
	Modular system for any connecting cable	Cable length 0.1 ... 30 m	539052 NEBU-... → Internet: nebu	–
	<ul style="list-style-type: none"> • Straight plug, 4-pin • Straight socket, M8x1, 4-pin 	Cable length 2.5 m	554035 NEBU-M8G4-K-2.5-M8G4	1
Push-in fitting, straight		Technical data → Internet: qsm		
	Connecting thread M5 for tubing O.D.	4 mm	★ 153315 QSM-M5-4-I	10
	Connecting thread M7 for tubing O.D.	6 mm	★ 153321 QSM-M7-6-I	10
	Connecting thread G1/8 for tubing O.D.	4 mm	★ 186095 QS-G1/8-4	10
			132036 QS-G1/8-4-100	100
		6 mm	★ 186096 QS-G1/8-6	10
			132037 QS-G1/8-6-100	100
		8 mm	★ 186098 QS-G1/8-8	10
			132038 QS-G1/8-8-50	50
	Connecting thread G3/8 for tubing O.D.	8 mm	★ 186111 QS-G3/8-8-I	10
		10 mm	★ 186113 QS-G3/8-10-I	10
12 mm		★ 186114 QS-G3/8-12-I	10	
16 mm		★ 186347 QS-G3/8-16	1	
Push-in fitting, angled		Technical data → Internet: qsl		
	Connecting thread M5 for tubing O.D.	4 mm	130831 QSMLV-M5-4-I	10
	Connecting thread G1/8 for tubing O.D.	4 mm	★ 186116 QSL-G1/8-4	10
			132048 QSL-G1/8-4-100	100
		6 mm	★ 186117 QSL-G1/8-6	10
			132049 QSL-G1/8-6-100	100
	8 mm	★ 186119 QSL-G1/8-8	10	
		132050 QSL-G1/8-8-50	50	
	Connecting thread G3/8 for tubing O.D.	8 mm	★ 186121 QSL-G3/8-8	10
10 mm		★ 186123 QSL-G3/8-10	10	
12 mm		★ 186124 QSL-G3/8-12	10	
Push-in fitting, angled, long		Technical data → Internet: qsl		
	Connecting thread G1/8 for tubing O.D.	4 mm	186127 QSLL-G1/8-4	10
			133015 QSLL-G1/8-4-100	100
		6 mm	186128 QSLL-G1/8-6	10
			133016 QSLL-G1/8-6-100	100
		8 mm	186130 QSLL-G1/8-8	10
			133017 QSLL-G1/8-8-100	100
	Connecting thread G3/8 for tubing O.D.	8 mm	186132 QSLL-G3/8-8	10
		10 mm	186134 QSLL-G3/8-10	10
12 mm		186135 QSLL-G3/8-12	10	



1) Packaging unit.

Festo core product range

- ★ Ready for dispatch from the Festo factory in 24 hours
- ☆ Ready for dispatch in 5 days maximum from stock

Motion Terminal VTEM

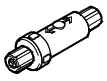
Accessories

Ordering data				Part no.	Type code	PU ¹⁾
Vacuum filters						
	Inline filter inserted in tubing line for tubing O.D.	4 mm	535883	VAF-PK-3		1
		6 mm	15889	VAF-PK-4		1
		8 mm	160239	VAF-PK-6		1
Blanking plug Technical data → Internet: b						
	For sealing unused ports	M5 thread	★ 3843	B-M5		10
		G1/8 thread	★ 3568	B-1/8		10
		G3/8 thread	★ 3570	B-3/8		10
Silencer Technical data → Internet: amte						
	For M7 thread		161418	UC-M7		1
	For G3/8 thread		★ 6843	U-3/8-B		1

1) Packaging unit.

Festo North America

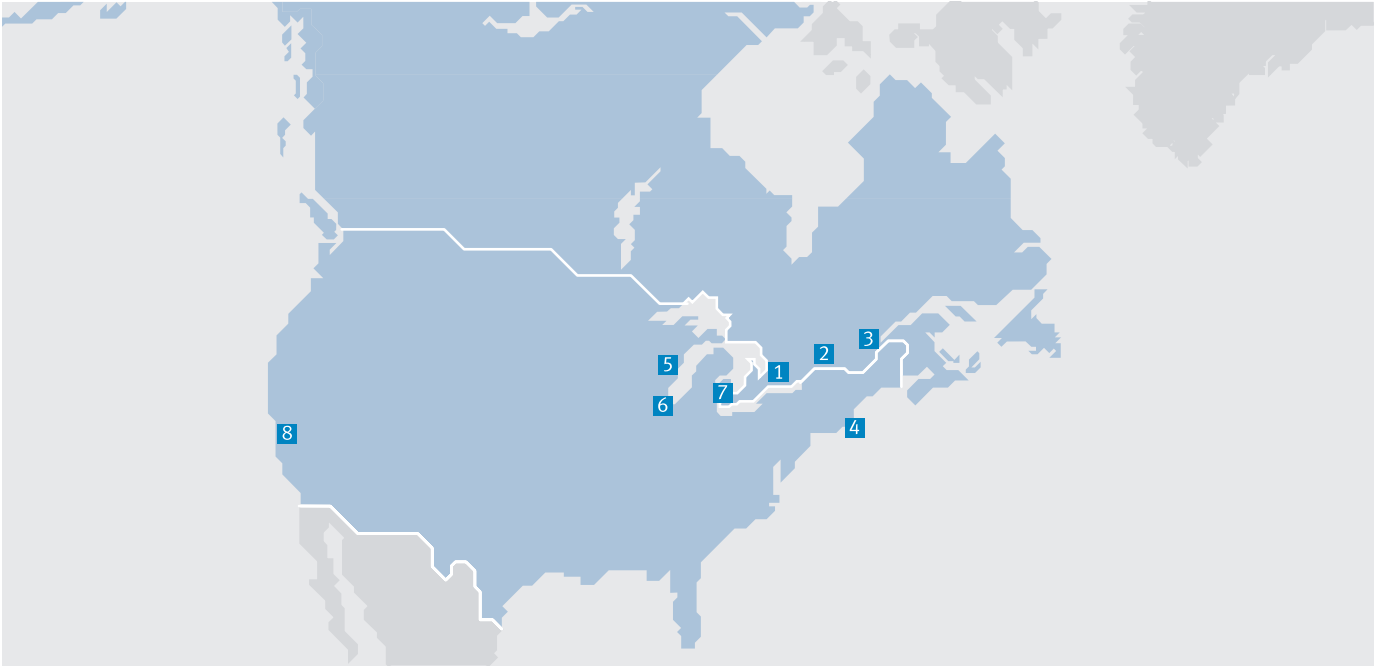

**1 Festo Canada
Headquarters
Festo Inc.**
5300 Explorer Drive
Mississauga, ON
L4W 5G4

2 Montréal
5600, Trans-Canada
Pointe-Claire, QC
H9R 1B6

3 Québec City
2930, rue Watt#117
Québec, QC
G1X 4G3



**4 Festo United States
Headquarters
Festo Corporation**
395 Moreland Road
Hauppauge, NY
11788

5 Appleton
North 922 Tower View Drive, Suite N
Greenville, WI
54942

7 Detroit
1441 West Long Lake Road
Troy, MI
48098

6 Chicago
85 W Algonquin - Suite 340
Arlington Heights, IL
60005

8 Silicon Valley
4935 Southfront Road, Suite F
Livermore, CA
94550

Festo Regional Contact Center

Canadian Customers

Commercial Support:
Tel: 1 877 GO FESTO (1 877 463 3786)
Fax: 1 877 FX FESTO (1 877 393 3786)
Email: festo.canada@ca.festo.com

Technical Support:
Tel: 1 866 GO FESTO (1 866 463 3786)
Fax: 1 877 FX FESTO (1 877 393 3786)
Email: technical.support@ca.festo.com

USA Customers

Commercial Support:
Tel: 1 800 99 FESTO (1 800 993 3786)
Fax: 1 800 96 FESTO (1 800 963 3786)
Email: customer.service@us.festo.com

Technical Support:
Tel: 1 866 GO FESTO (1 866 463 3786)
Fax: 1 800 96 FESTO (1 800 963 3786)
Email: product.support@us.festo.com